



# OPERATING MANUAL FOR NATURAL REFRIGERANT CABINETS

## IMPORTANT INFORMATION (PLEASE RETAIN THIS DOCUMENT)

This Manual covers the installation, operation and routine maintenance requirements for the following Williams Refrigeration products:

### Williams Medi+ Range

Please read this Manual carefully before connecting the appliance.

Provided the instructions in this Operating Manual are read and implemented correctly, the optimum performance and reliability of your equipment should be maintained.

We assume the installer, user and service provider are appropriately trained, skilled and competent to properly and safely carry out the work, and will use the necessary safety equipment, and take the necessary precautions required of their intended work.

Improper installation, maintenance or repair may put the user at considerable risk.

Williams cabinets are available in a choice of temperature ranges.

### Temperature parameters are set as follows:

High Temperature (H) +2°C (35.6°F) / +8°C (46.4°F)

Low Temperature (L) -18°C (0°F) / -22°C (-8°F)

### General Regulations

#### Declaration of Conformity:



Refrigerant Designation	Global Warming Potential
HC - R290	3
HC - R600a	3

Williams Refrigeration declares that all products manufactured by Williams Refrigeration comply with the applicable directives, and those products are therefore declared to be in conformity with the provisions of the above legislation.

Model No.: .....

Serial No.: .....



## IMPORTANT REFRIGERATION AWARENESS

# WARNING



**SYSTEM CHARGED WITH FLAMMABLE REFRIGERANT**

**REFRIGERANT:R290 / R600A (REFRIGERANT GRADE PROPANE AND ISOBUTANE RESPECTIVELY ONLY)**

Ensure all operatives are aware the appliance contains an environmentally friendly but flammable refrigerant.

**Technical Safety and Advice**

All appliances are only to be installed by persons who are appropriately trained, skilled and competent to properly and safely carry out the work, and serviced by qualified engineers for the handling of hydrocarbon refrigerants

Ensure procedures are adhered to in the following Operating Manual.

**Should a suspected leak become apparent, immediately evacuate the area and remotely switch off the cabinet.**

**DO NOT remove the plug from the socket as this could act as a source of ignition. Leaking refrigerant may ignite and cause injuries.**

Contact Williams Refrigeration on +44 (0) 1553 817 000, stating the suspected fault.

---

## IMPORTANT SAFETY INFORMATION

---

**Warning:**

Do not store explosive substances such as aerosol cans with a flammable propellant in this appliance.

**Warning:**

Do not use electrical appliances inside the storage compartments of this appliance.

**Warning:**

Keep ventilation openings of the appliance enclosure or the structure of built in equipment, clear of obstruction.

**Warning:**

Do not use mechanical devices or other means to accelerate the defrosting process.

**Warning:**

Do not damage the refrigerant circuit, i.e. pipe work or components.

## ELECTRICAL



The appliance must be disconnected from its power source during cleaning; when maintenance and the replacement of parts is required, the equipment must be safely disconnected and isolated from the power supply using a lock-off system at the isolation device.



It is advised that the electrical supply to the equipment is protected by an appropriately selected Residual Current Device (RCD) with a rating no greater than 30mA.



If the supply cord is damaged, it must be replaced by a service engineer or other qualified person. Only the supply cord supplied by Williams Refrigeration must be used.



Fixed wiring appliances (those not supplied with a plug) shall incorporate a switch disconnecter to meet the specification of IEC 60947; this is to be installed within the fixed wiring installation in accordance to the local wiring rules / regulation to provide all pole disconnection of the power supply.

## IMPORTANT SAFETY INFORMATION

---



### **Warning! Damage to health due to infectious liquids and pathogenic germs.**

- When handling infectious liquids and pathogenic germs, observe the national regulations, the biosafety level of your laboratory, the material safety data sheets, and the manufacturer's application notes.
- Wear your personal protective equipment.
- For comprehensive regulations about handling germs or biological material of risk group II or higher, please refer to the "Laboratory Biosafety Manual" (source: World Health Organisation, Laboratory Biosafety Manual, the current edition).

### **INFORMATION ON PRODUCT LIABILITY**

In the following cases, the designated protection of the device may be affected. Liability for any resulting damage or personal injury is then transferred to the owner:

- The device is not used in accordance with the operating manual.
- The device is used outside of its intended use.
- The device is used with accessories or consumables that are not recommended by Williams Refrigeration.
- The device is maintained or repaired by persons not authorised by Williams Refrigeration.
- The user makes unauthorised changes to the device.

# INSTALLATION

## REMOVAL OF REDUNDANT APPLIANCES

If the product needs to be disposed of, the relevant legal regulations must be observed.

Within the European Community, the disposal of electrical devices is regulated by national regulations based on EU Directives pertaining to waste electrical and electronic equipment (WEEE).

According to these regulations, any devices supplied after August 13, 2005, in the business-to-business sphere, to which this product is assigned, may no longer be disposed of in municipal or domestic waste. To document this, they have been marked with the following marking:



Do not dispose of batteries together with domestic waste. Dispose of batteries in accordance with local, legal regulations.

Refrigeration appliances contain refrigerant and gases in their insulation and must be disposed of professionally by a licensed waste management contractor.

Please ensure that old or redundant refrigeration appliances are disposed of safely and legally. It is recommended that doors are removed prior to disposal in order to ensure safety.

Because disposal regulations may differ from one country to another within the EU, please contact your supplier if necessary.

## UNPACKING

Remove all external and interior packing and accessories. Ensure all such material is disposed of safely.

Check that no damage has occurred to the appliance, the tubing of the refrigeration system power cable and plug top during transit. If damage has occurred do not use the appliance.

The appliance should be installed in a well ventilated room on a flat and level floor.

## PROTECTIVE COATING

The polished stainless steel surfaces are protected during manufacturing and transport by an adhesive plastic coating.

This should be removed prior to placing your appliance into use. Carefully peel away to reveal the polished stainless steel surface. Care should be taken to ensure that no adhesive residue remains on the surface. Any stubborn or tough adhesive marks can be removed by following the advice on Page 10.

## INSTALLATION

During the initial start up, high temperature alarm may sound while the appliance reaches operating temperatures. Allow the appliance to stabilise at the set point before storing product.

**If the appliance has been laid on its back or tipped, DO NOT switch on immediately. Leave in an upright position for at least 3 hours before switching on.**

## VENTILATION

Refrigerators generate a considerable amount of heat and, if operated in a small unventilated room will quickly cause the room temperature to become excessive. This could cause the motor to overheat and possibly damage the compressor. At the very least, such an installation will cause the unit to use an excessive amount of electricity.

In addition to ventilation in a room, please ensure that cabinets with top-mounted systems have 500mm clearance between the cabinet top and the ceiling for engineer access and ventilation. For all other cabinets, please ensure a minimum clearance of 50mm is provided around the unit to ensure efficient and effective performance.

**Do not block vents by stacking boxes on top or in front of the unit as this could affect performance and give rise to safety risk.**

## LEVELLING (CASTORS/FEET)

The appliance should stand level to ensure the correct operation of self-closing doors and proper drainage of condensate from the evaporator.

Models fitted with castors are non-adjustable. Therefore a level platform / floor should be provided where the appliance is to be located. Where swivel and brake castors are fitted and it has been positioned, please ensure its brakes have been activated by pressing the metal bar down. Remember to release the brakes before trying to move it.

On models fitted with levelling feet, levelling may be achieved by adjusting them first.

### MAINS CONNECTION

**Refrigeration equipment is commonly used in environments located close to liquids, and is usually operated in and around damp areas, or where restricted movement for installation and service is evident.**

**Great care must be exercised at all times when installing, operating, or servicing this appliance.**

The equipment is to be powered by a suitable socket outlet which provides means of switching off and/or disconnecting the power supply to the equipment for cleaning or maintenance purposes. It should be positioned in a clearly visible location, and be easily accessible at all times. It is advised that a label be fixed adjacent to the designated socket outlet for identification purposes, stating the outlet is used to power the specific medical refrigeration equipment.

For appliances fitted with a moulded plug for safety, ensure that the mains power cable is extended free from the refrigeration system to avoid entanglement. If a plug or mains cable requires replacement, contact the Williams Spares Office on +44(0)1553 817017.

The installation of a fixed appliance and periodic inspection should only be undertaken by a qualified, skilled, and competent electrician; and connected to the correct power supply suitable for the load as stipulated by the appliance data label.

The electrical installation and connections should meet the necessary requirements to the local electrical wiring regulations and any electrical safety guidelines.

**All appliances rely upon a suitable connection to earth to ensure safe operation. If in doubt, contact a qualified, skilled, and competent electrician before using the appliance.**

**We recommend:-**

- **Supplementary electrical protection with the use of a residual current device (RCD)**
- **Fixed wiring appliances incorporate a switch disconnector for purposes of safe isolation to meet the specification requirements of IEC 60947**

### SUPERVISORY & NETWORK CONNECTIVITY (OPTIONAL)

There is an option to connect the Medi+ refrigeration equipment to third party supervisory networks and systems such as Building Management Systems (BMS), and IoT cloud based systems via an RS485 Modbus data connection. This will allow for a comprehensive supervision of the equipment operating parameters and status, such as internal temperature, defrost cycles and alarms.

The Medi+ equipment controller also provides a volt free contact, which can be connected to a BMS to monitor general alarm conditions.

**NB: A proprietary cable from Williams Refrigeration is required and, only suitably qualified and competent engineers should install this equipment to such systems. For more information, please contact Williams Refrigeration on +44(0)1553 817000.**

### MAINS POWER SUPPLY FAILURE ALARM (OPTIONAL)

This alarm is to help safeguard stored medical samples/items by announcing when a failure of the mains power supply has occurred. An audible (95dB sounder), and a visual alarm (red flashing 'Power failure' indicator) will activate in the advent of a mains power supply failure.

The alarm will be continuous for a minimum of 12 hours, (whilst the mains power supply failure remains), powered by a rechargeable battery integrated into the alarm circuit; however, the sounder can be muted at any time by pressing the 'Mute' button. Once muted, a blue flashing indicator signifies that the alarm has been muted. The red flashing 'Power failure' indicator will continue to be active whilst there is a failure of the mains power supply.

When the mains power supply is reinstated the 'Alarm muted' function MUST be reset by pressing the mute button once more, cancelling the blue flashing indicator signifying that the alarm circuit is ready to sense a power failure.

**IMPORTANT: for the rechargeable battery to receive a full charge, it is advised that the mains power supply is connected for at least 24 hours. As with all batteries, the rechargeable battery has a finite operational life which will vary dependent of a number of factors, it is therefore, advised that the mains power supply failure alarm is checked by a service engineer as part of the routine periodic servicing of the refrigerator. Only replace the battery with a Williams Refrigeration approved and supplied battery.**

## SHELF/SLIDE FITTING

When positioning slides on standard cabinets and counters, present slide to racking by holding it in the opposite hand to the side of the cabinet to that which they are to be applied. Present slide at 45° angle (figure 1). When in place, let slide drop into position to create a horizontal ledge on which the shelves will sit.

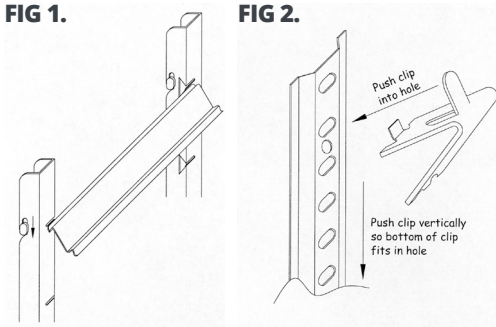

The WMP135 models are fitted with pilaster and clips (figure 2) for fitting.

## LOADING / SHELF DISTRIBUTION

**Before loading, allow the appliance to reach its normal operating temperature.**

- Never load beyond capacity.
- Always store items within shelves.
- Uniform product temperature is maintained by air circulation, ensure even loading.
- Do not place items against the rear plenum or pushed against side walls.

When loading the appliance, please ensure that its load is equally distributed throughout and ensure air can circulate around and through stored products.

Care should be taken when loading the appliance. Do not obstruct the air ducts. Take care of any parts with possible sharp edges.

## LOCKING FACILITY

On models with a locking facility, it is recommended that the key be removed from its lock during normal working use. This will prevent bending or breaking of the key which could result in the lock having to be replaced.

Removing the key will also prevent accidental locking when the door is open. This will prevent the door from closing properly and cause the interior temperature to rise. If not checked in time, a loss of product may result.

# CONTROLLER

## CONTROLLER / DISPLAY

The display should be checked daily to ensure that the correct temperature is being maintained.



 Info / Setpoint button.

 Manual defrost / Decrease button.

### Temperature set point

To adjust the cabinet temperature set point;

- Press the “i” button to display the set point value.
- Keeping the “i” button pressed, use the “▲” and “▼” buttons to adjust the value.
- Releasing the “i” buttons stores the new value.

### Information menu

It is possible to display more temperature information, such as maximum and minimum temperatures by accessing the information menu. This can be viewed by pressing the “i” button, and releasing. Using the “▲” and “▼” buttons the following information can be displayed;

- “t1”: Probe 1 (air) instantaneous temperature.
- “t2”: Probe 2 (evaporator) instantaneous temperature.
- “th1”: Maximum probe 1 recorded temperature.
- “tL1”: Minimum probe 1 recorded temperature.

Whilst accessing the information menu, it is possible to reset the “th1” or “tL1” recorded values as follows;

- First select either “th1” or “tL1” to reset using the “▲” and “▼” buttons.
- Display the value to reset by pressing the “i” button.
- While keeping the “i” button pressed, press the “x” button to reset the value.

 Thermostat output

 Fan output

 Defrost output

 Alarm

 Increase button

 Exit

To exit the information menu, either wait 10 seconds, or press the “x” button.

### Alarms

An alarm is reported via the display through the flashing of an abbreviation indicating its cause:

- “HI”: Cabinet high temperature alarm.
- “LO”: Cabinet low temperature alarm.
- “DO”: Door open alarm.
- “CL”: Condenser cleaning warning (if enabled).
- “E1”: Failure of probe T1 (Air).
- “E2”: Failure of probe T2 (Evaporator).

### Internal Light

If the Medi+ refrigerator is fitted with an optional light(s), an independent light switch will be provided, which will allow control over the internal light(s).

### DEFROST OPERATION

The controller will instigate an automatic defrost cycle. The refrigeration system is turned off whilst the electric defrost system is switched on. This defrosts the evaporator coil. The operation raises the temperature of the Medi+ cabinet slightly for a short period but does not affect the stored product.

When defrost is in progress, the defrost indicator on the control panel will become illuminated and “dEF” is displayed until the defrost cycle has finished.

A manual defrost can be activated by pressing and holding the “▼” button on the controller for 2 seconds.



## HI-LO ALARM

The Medi+ controller features a built in audio/visual Hi-Lo alarm. If the temperature within the cabinet storage area exceeds the factory set alarm temperature and duration, the control will display a temperature alarm and activate a sounder. The alarm can be cancelled by pressing the “i” button.

## PROBE FAIL SAFE FEATURE

The Medi+ controller features a special fail-safe condition. In the event of a temperature probe failure the compressor will not continue in normal sequence.

Instead the compressor will switch to a five minute cycle, which it cycles on for five minutes then off for five minutes. The normal compressor cycle will be restored upon the repair of the probe fault. This feature is designed to avoid the compressor overheating and protect the stored contents of the equipment until manual intervention is possible.

## LOCKING/UNLOCKING THE CONTROLLER KEYPAD

It is possible to lock the electronic controller interface keypad to prevent accidental changes to, and general ampering or unauthorised changes to, the controller operation including changes to temperature set points.

To achieve this, follow the sequence below;

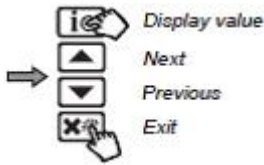

## APPLIANCE ROUTINE MAINTENANCE / CLEANING

### ROUTINE MAINTENANCE

**Safely disconnect the appliance from the power supply before cleaning, servicing or undertaking general maintenance.**

We recommend that you undertake regular preventative maintenance using a qualified service provider in order to get the best from your equipment.

### CLEANING

Always wear appropriate personal protective equipment (PPE) when cleaning the appliance. Care should be taken for parts with possible sharp edges.

Stainless steel is naturally corrosion-proof and needs no additional protective coating to maintain its gloss and usability for a long time.

Abrasive or corrosive cleaning agents should never be used. These can damage surfaces and cause corrosion. They include:

- Cleaners containing chloride;
- Bleaches containing hypochlorite (if accidentally spilled on stainless steel, rinse off with water immediately and thoroughly);
- Silver polish

If the cabinet exterior is looked after correctly it will retain an “as new” finish for many years. A damp cloth is usually sufficient for wiping away light dirt and finger marks and normal day to day cleaning should be carried out with a soft cloth and soapy water.

Dry thoroughly afterwards and where possible remove all racking and shelving fittings to aid the process.

For stainless steel with visible polishing grains, clean the steel with the grain - not against the grain. When water has been used for cleaning or rinsing, wipe the surface dry to prevent water from drying and forming watermarks, especially in areas with hard water. Avoid this type of watermark by using distilled water.

For tougher spots, creamy polishes like CIF original cream can be effective. Light pressure should be used when cleaning with the grain. The cleaning process should be repeated in order to prevent any dirt becoming lodged in the surface grain again.

CIF original cream cleaner can also be used for wiping off water spots and can alleviate discoloration. Remove this type of residue by rinsing with clean, preferably distilled water and wipe away any remaining streaks of polish or watermarks.

Tough grease or oil marks can also be removed using denatured alcohol or acetone. There is no risk of corroding stainless steel by using such solvents. For ease of use limit the amount of solvent used. Wash more than once using a pure solvent on a clean soft rag until all traces of the greasy residue are removed.

### Specialist Stainless Steel Cleaners

Innosoft B570 is a special deep cleaner that is suitable for the intensive cleaning of contaminated stainless steel surfaces, and removes stains and oxides in a single operation.

Innoclean B580 completely removes any residues left after the use of Innosoft B570 and passivates the surface which helps to prevent further corrosion.

With regards to the above recommended cleaners, always check that they will not have any detrimental effect to the stored contents.

### SHELF / SUPPORT/ RACKING REMOVAL

First remove the shelves, then remove the shelf supports by grasping firmly in the centre and lifting slightly. Turn the shelf support towards the interior of the cabinet by pushing it in the centre as you twist the support through 90°. The shelf support will be released. (NB: the supports are designed to be anti-tilt and you may therefore experience some resistance at first which will be overcome with practice). When all shelves have been removed, remove the racking by lifting up and over the nylon retaining blocks.



### CONDENSER CLEANING

Regular maintenance should be carried out on a regular basis by competent / trained personnel. The condenser is part of the refrigeration unit and is located in the unit compartment.

Brush fins vertically with a stiff brush, taking care not to damage them or to push dirt / dust further in, and then vacuum away.

**FIG 3.**

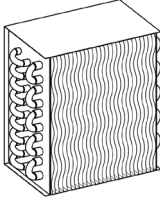

### BREAKDOWN

In the event of a breakdown, please contact Williams Refrigeration or your Service Provider

When calling, please advise model and serial number. This information can be found on the data plate inside the appliance. Please ensure that all redundant parts are disposed of safely and legally.

### TOP MOUNTED CABINETS

(WMP620 - WMP1295)

The condensing unit and refrigeration equipment can be accessed from above or in some cases behind. Remove fixings in the top and bottom edges of the unit cover and pull the unit cover away from the cabinet and retaining clips.

### BOTTOM MOUNTED UNITS

(WMP523)

Pull the unit cover away from the cabinet and retaining clips.

### CLEANING / REPLACING THE GASKET

Door gaskets should be checked and cleaned regularly and replaced if damaged. To clean the gasket, wipe with warm soapy water and a soft cloth, ensuring it is completely dry before closing the door.

**DO NOT** use a sharp knife to clean or scrape the gasket. Damaged gaskets do not seal correctly and can increase the amount of electricity consumed, seriously affecting the efficiency and performance of the appliance.

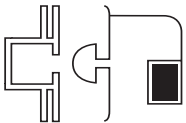

Damaged gaskets are easily replaced. Simply pull out the existing part and push the new gasket into the channel (gasket retainer) at the centre and work along, pushing gasket into channel.

### EVAPORATOR/DRAINLINE

Inspect periodically to ensure the drain hole is not blocked.

**TROUBLE SHOOTING INFORMATION AND ALARM CODES**

<b>Fault Display</b>	<b>Possible Cause</b>	<b>Action</b>
Cabinet not operating	No power supply	Check fuse or power source
Cabinet not maintaining temperature	1. Dirty condenser	Clean
	2. Air circulation restricted	Remove restriction
	3. Defective fan motor	Call engineer
	4. Defector compressor relay	Call engineer
	5. Loose electrical connection	Call engineer
Faults displayed by control	E1 or E2 - Control probe failure	Call engineer
	HI or LO - High/low temperature alarm*	Call engineer
	DO - Door open alarm	Shut door
	CL - Condenser requires cleaning	Remove cover and clean condenser fins with a clean brush

**TROUBLE SHOOTING INFORMATION FOR THE MAINS POWER SUPPLY FAILURE ALARM (OPTIONAL)**

<b>Fault</b>	<b>Possible Cause</b>	<b>Action</b>
The sounder is not working when mains power supply is turned off	Mute switch activated	Check mute switch
The red 'Power failure' indicator is not illuminating when mains power supply is turned off but the sounder activates	Indicator not working	Call engineer
The sounder and red indicator not working when the mains power supply is turned off	Battery or alarm circuit faulty	Call engineer
The sounder and red indicator only work for a short period when the mains power supply is turned off	Battery requires full charge or requires replacement	Call engineer if a full charge does not resolve the issue

### CHOOSING GENUINE SPARE PARTS

Choosing the correct spare parts is vital to the ongoing running of your appliance - that's why Williams Refrigeration offer a comprehensive network of servicing, support and spare parts all available directly from Williams.

Our spare parts are exactly the same quality and standard as we use to build your appliance and have been rigorously checked, tested and inspected to ensure the very best quality and exact fit.

You can contact us directly for everything from fault diagnosis to parts selection and ordering. Simply provide the serial number of your appliance and we will do the rest to ensure you receive the right part first time.

**For further information please call our Spares Department on 01553 817017  
or email [spares@williams-refrigeration.co.uk](mailto:spares@williams-refrigeration.co.uk)**

## PARTS & LABOUR WARRANTY POLICY - UK ONLY

Our warranty applies to equipment manufactured by Williams Refrigeration and equipment bearing the Williams name plate and serial number identification tag.

We undertake, in conjunction with the supplying agent, distributor or representative, to repair free of charge during our standard business hours any such piece of equipment or part thereof used which is found to be faulty in either materials or workmanship subject to the further conditions below:-

### WARRANTY TERMS AND PRODUCTS COVERED

We offer a **24 months Warranty** from our original date of sale with the following Williams equipment:

1. Williams Medi+ Range - WMP

### WARRANTY TERMS

Our warranty is offered where the equipment has been installed correctly and has not been subject to misuse or abuse and is functioning correctly.

The equipment was purchased by the authorised supplying distributor direct from Williams Refrigeration and not through a wholesaler or other supplier whose warranty terms may be different.

The Warranty Policy shall be non-transferable.

Replacement of defective equipment can only be made with the approval of Williams Refrigeration.

Any repair under warranty will only be carried out with the product in its position of operation or in a suitable location on the customer's premises. If the product has to be removed for security or any other reason, this will be subject to additional charge (may include hydrocarbon charged equipment).

Warranty work will be covered by Williams Refrigeration or by one of its appointed service agents between the hours of 8.00am and 5.00pm Monday to Friday. Any works undertaken outside of these hours are chargeable.

### CLAIMS PROCEDURE

If a customer wishes to make a claim under the terms of this warranty, the following procedure should be observed:

1. Contact the supplying agent, representative or distributor.
2. Quote the equipment model, serial number and date of installation. The serial number is located

on the product identification plate inside the cabinet, modular product door frame or similar location. It is recommended that operators should also record the serial number on the operating instruction booklet supplied with the product.

3. Contents risk and insurance responsibility remains at all times with the customer.

### EXCEPTIONS TO STANDARD WARRANTIES

1. The Standard warranty applies to equipment located in Mainland GB only and excludes locations subject to restricted or secure access, offshore and marine applications. Additional time and travel charges may be applied to the following locations – Isle of Wight, Channel Islands, Isle of Man, Northern Ireland and Scottish Isles.
2. Any fault that is not reported within 10 working days of being discovered.
3. Service calls to equipment under warranty, or service calls made under chargeable arrangements will be carried out in accordance with standard conditions of sale. Unless otherwise specified, a maximum of 15 minutes of administrative time, not spent directly carrying out servicing work, is provided for within the supply. Any requirement for staff attending the call to spend greater time than 15 minutes due to administrative requirements, such as on waiting time or security clearance, or health and safety risk assessments, will be chargeable at our prevailing rate. We reserve the right to apply Time Travel & Call out charges if no fault is found with the product or access is either restricted or denied to our attending engineer.
4. No claim shall exceed the original selling price.
5. Claims for contents stored in the equipment supplied (including pharmaceutical or other items) and any consequential loss how so ever arising are excluded under our warranty terms.
6. Components including gaskets, doors, drawers, handles, shelves, tray slides, all internal fixings, plug and lead, connectors, the outer shell, castors / legs, temperature probes, refrigerant and blockages as well as consumable items such as (but not limited to) batteries, fuses, light bulbs, printer cartridges, keys, glass and paper roll.

7. Equipment manufactured to the customers' own design, Williams Refrigeration will not be liable for any defect, non performance or improper operation of the equipment arising from any drawing design or specification supplied by the customer, their representative or agent.
8. Second hand equipment.
9. The customer uses or installs the equipment in such a way that it exceeds its design envelope or operates the equipment at control parameters other than those provided as standard factory settings.
10. The customer fails to observe commonly accepted operating practices.
11. The customer has not properly cleaned or maintained the equipment or carried out necessary servicing, including cleaning of the condenser, in accordance with instructions, literature or directions issued by Williams Refrigeration. (Operating Instructions are supplied with all equipment but also available at [www.williams-refrigeration.co.uk](http://www.williams-refrigeration.co.uk)).
12. Equipment fails through improper installation by others, misuse, abuse, accidental damage, power loss or fluctuations, fire, flooding or acts of god.
13. Any third party item(s) connected to the equipment that may affect performance.
14. The customer permits persons other than those authorised by Williams Refrigeration to perform or affect repairs or adjustments to the equipment.
15. If authorised representatives of Williams Refrigeration are denied full and free rights of access to the equipment for inspection during normal business hours as previously stated.
16. If Repairs are made using spare parts or replacement items not supplied or preauthorised by Williams Refrigeration.
17. The initial equipment supply date shall apply for warranty validity for the subsequent supply of replacement of parts or products.

### EXTENDED WARRANTY

Extended Warranty offers the opportunity to protect your equipment (subject to conditions outlined) for an additional period of up to 5 years inclusive of original warranty periods.

Should you require Extended Warranty, state on your order or notify the Dealer or Williams Sales Manager at the time of purchase and they will be able to arrange it for you.

To ensure your Extended Warranty Policy remains valid, at least one maintenance / service visit per year must take place in years 2, 3, 4 and 5.

**For further information or clarification please call 01553 817000 or email to [info@williams-refrigeration.co.uk](mailto:info@williams-refrigeration.co.uk) or write to Williams Refrigeration, Bryggen Road, King's Lynn, Norfolk, PE30 2HZ**



## Design Excellence : Cool Technology

### Williams Refrigeration

Bryggen Road  
North Lynn Industrial Estate  
King's Lynn  
Norfolk PE30 2HZ  
Sales Tel: +44 1553 817000  
Sales Fax: +44 1553 817111  
Spares Tel: +44 1553 817017  
Spares Fax: +44 1553 817020

[info@williams-refrigeration.co.uk](mailto:info@williams-refrigeration.co.uk)  
[www.williams-refrigeration.co.uk](http://www.williams-refrigeration.co.uk)

### Williams Silver Frost

2 rue Conventionnel Huguet  
23000 GUERET  
France  
Tel: +33 5 55 52 27 88  
Fax: +33 5 55 62 10 61

[info@williams-refrigeration.fr](mailto:info@williams-refrigeration.fr)  
[www.williams-refrigeration.fr](http://www.williams-refrigeration.fr)

### Williams Dubai

603-604 Building 1B  
Dubai Design District  
P.O. Box 333215  
Dubai  
United Arab Emirates  
Tel: +971 4 510 8203

[sales@williams-dubai.ae](mailto:sales@williams-dubai.ae)

### Williams Refrigeration Australia

38-42 Gaine Road  
Dandenong South, Victoria 3175  
Australia  
Tel: +61 3 8787 4747  
Fax: +61 3 8787 4787

[sales@williamsref.com.au](mailto:sales@williamsref.com.au)  
[www.williams-refrigeration.com.au](http://www.williams-refrigeration.com.au)

### Williams Refrigeration Hong Kong

Unit C, 12/F., Roxy Industrial  
Centre,  
58 - 66 Tai Lin Pai Road, Kwai  
Chung,  
New Territories, Hong Kong  
Tel: +852 2407 5422  
Fax: +852 2407 3767

[sales@williams-hongkong.com](mailto:sales@williams-hongkong.com)  
[www.williams-refrigeration.com.hk](http://www.williams-refrigeration.com.hk)

[www.williams-refrigeration.com](http://www.williams-refrigeration.com)

Williams Refrigeration is a trading name of AFE Group Limited.  
Registered in England & Wales under Registered Number  
3872673. Registered Office Address - Bryggen Road,  
North Lynn Industrial Estate, King's Lynn, Norfolk, PE30 2HZ

