

MODEL: **HyGenikx HGX-W-30-F**



# HYGENIKX+

HyGenikx Air & Surface Steriliser System with 30m2 coverage. White finish. For use in Food areas such as cold rooms and food prep areas

**Area of use:** Food  
**Range of cover:** 30m2  
**Colour finish:** White finish

**FEATURES & BENEFITS**

- Kills Escherichia coli (E. coli), Staphylococcus aureus (S. aureus), Clostridium difficile (C. difficile), Aspergillus fumigatus, and other primary sources of infections
- Significantly improves hygiene standards to levels impossible to maintain with traditional cleaning methods alone
- Eliminates bacteria, viruses, moulds, fungi and volatile organic compounds (VOCs), both in the air and on exposed surfaces, even in the hardest to reach places
- Safe to use and for the environment
- Eradicates unpleasant odours by tackling them at source
- Proven to deplete harmful Listeria monocytogenes and Listeria innocua from surfaces to undetectable levels
- Improves infection control for staff and customers
- Proven to reduce spoilage by extending the shelf-life of perishable food on average by 58%, and up 150% for certain produce
- Low power consumption, 9-13W
- Easy to change lamp and backup battery, requires no onsite engineer
- Power via a plug that allows flexible installation and easy connection to existing sockets or to switched spurs
- Food area models are supplied with food safe shatter-proof lamps

**TECHNICAL INFO**

- Combines technologies: Germicidal Oxidation, Germicidal Irradiation, Dual waveband Plasma Quattro
- Services: 220/50/1. Uninterrupted supply - 24 hour operation required. High level
- Dimensions: 400 x 135 x 110mm
- EC declaration of conformity - CE mark
- 1.8m power cable with plug to be connected to suitably isolated socket or fused spur 1.8m power cable with plug to be connected to suitably isolated socket or fused spur. Plug type supplied is dependent on country/location. 3-pin (type G), or 2-pin (type C) Europlug.
- Low Voltage Directive (LVD) 2014/35/EU
- Electromagnetic Compatibility Directive (EMC) 2014/30/EU
- Manufactured in accordance with European standards
- Produced under the control of our comprehensive BSI ISO 9001:2015 Quality Management
- Class 2 certified for electrical insulation
- System (certificate FS 616985)

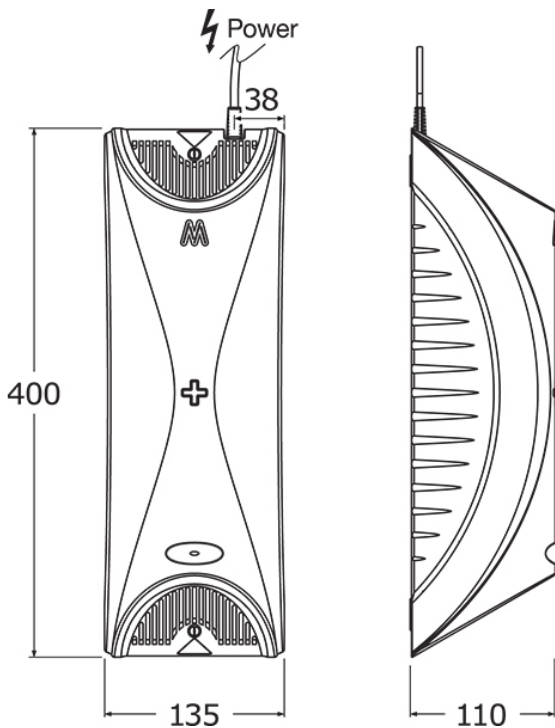

Dimensions are in millimeters. If a Cad file is required please visit [www.mechline.com](http://www.mechline.com).

**MAINTENANCE & CLEANING**

Cleaning chrome: Do not use abrasive, chlorine or acid-based cleaning products. Avoid contact with concentrated bleach. Clean with soapy water using a cloth or sponge.



MECHLINE DEVELOPMENTS LIMITED

Tel: +44 (0)1908 261511 | Email: [info@mechline.com](mailto:info@mechline.com) | Web: [www.mechline.com](http://www.mechline.com)