

700 SERIES MODULAR COOKING EQUIPMENT
OPTIMUM RANGE



HOBART UK,
SOUTHGATE WAY,
ORTON SOUTHGATE,
PETERBOROUGH
PE2 6GN

TELEPHONE - 0844 888 7777
www.hobartuk.com

700 Series - Gas Hobs

B207FV4DG-10

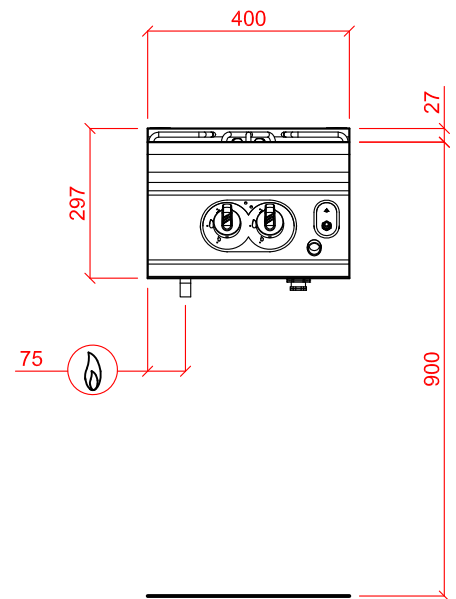
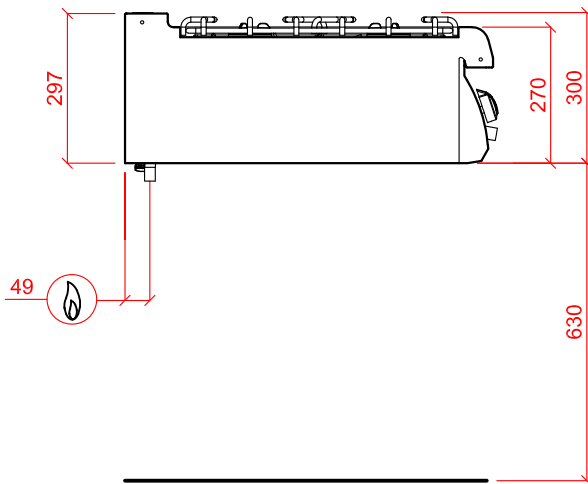
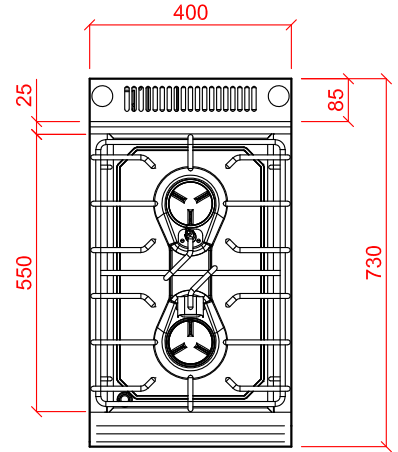

Device Number	Description	Gas/Electric Loading	Dimensions (m.m.) (w x d x h)
B207FV4DG-10	2 Burner gas hob (Nat Gas)	9kW	400 x 730 x 270

1/2" CONNECTION, 20mBAR

SPECIAL NOTE:
INSTALLATION MUST COMPLY WITH CURRENT GAS SAFETY REGULATIONS AND BS 6173

PLOT SCALE: 1:15