



Warewashing



Dishwasher ranges GC/GCP GX/GP FX/FP



Installation and operation manual

(Original operation manual)

EN

Table of Contents

1	Notes on the documentation	4
1.1	Application	4
1.2	Layout of the documentation	4
1.3	Symbols used	4
2	Safety instructions and regulations	5
2.1	Hazard levels	5
2.2	Layout of safety instructions	5
2.3	Basic safety instructions	5
2.4	Property damage	7
3	Product description	7
3.1	Intended purpose	7
3.2	Designation	7
3.3	Technical data	8
4	Controls	8
4.1	Overview	8
4.2	Main display functions	9
4.3	Navigating, selecting and setting	9
5	Installation	9
5.1	Personnel qualification	9
5.2	Special safety instructions	9
5.3	Transporting to the installation location	10
5.4	Removing the packaging	10
5.5	Installing the machine	10
5.6	Connecting to the power supply	11
5.7	Connecting the water	11
5.8	Connecting the drain	12
5.9	Retrofitting integrated chemical container (optional)	12
5.10	Retrofitting chemical suction lances with low-level sensors (optional)	12
6	Commissioning	13
6.1	Personnel qualification	13
6.2	Checking the software version	13
6.3	Starting the commissioning procedure	13
6.4	Setting the language	13
6.5	Setting the date	13
6.6	Setting the time	14
6.7	Select connected load	14
6.8	Setting the water hardness (optional)	14
6.9	Filling the salt reservoir (optional)	14
6.10	Filling the chemical container and suction hoses	15

6.11	Completing the commissioning procedure.....	16
7	Operation.....	16
7.1	Personnel qualification.....	16
7.2	Special safety instructions.....	16
7.3	Notes for optimum wash results.....	16
7.4	Preparations for washing.....	17
7.5	Displaying and selecting the program.....	17
7.6	Washing.....	19
7.7	Switching off the machine.....	19
7.8	Cleaning.....	20
7.9	Executing hygiene cleaning.....	20
7.10	Executing the basic cleaning program for washware.....	21
7.11	Displaying the temperatures.....	22
8	Setting options, operating and hygiene data.....	22
8.1	Information on the operation, machine and service contact data.....	23
8.2	Setting options and hygiene data.....	23
8.3	Making the general settings.....	24
8.4	Set temperature display.....	25
8.5	Setting the acoustic signal.....	25
8.6	Making the chemical settings.....	25
8.7	Monitoring external water treatment.....	25
8.8	Setting the water hardness (optional).....	26
8.9	Setting VAPOSTOP ² and TOP-DRY.....	26
8.10	Hygiene and operating data.....	26
8.11	Setting the timer.....	26
8.12	WLAN.....	26
8.13	Temperature level.....	27
9	Fault indications and problems.....	27
9.1	Fault indications.....	27
9.2	Remedying the problem.....	30
10	Maintenance.....	31
11	Disposal.....	32
12	Product disclaimer.....	32
13	Conformity.....	33

1 Notes on the documentation

1.1 Application

This document contains the most important information for the installation and commissioning of the machine by qualified personnel, as well as the information required for day-to-day operation by the operator.

- ▶ Keep the operation manual and all referenced documents in a safe and accessible place.
- ▶ Store the operation manual in a suitable container protected from humidity and dirt deposits.
- ▶ If you sell the machine, pass on the installation and operation manual.

1.2 Layout of the documentation

Referenced documents are all instructions that describe the installation, operation, maintenance and repair of the device, as well as additional instructions for all accessories used.







For the operator:



- Comic Card (brief instructions)
- Operating instructions

For the specialised tradesman:

- Installation instructions
- Service Manual
- Service Software Manual
- Trouble shooting list
- Circuit diagram
- Spare parts catalogue

1.3 Symbols used

Symbol	Meaning
	Beware of hazardous electrical voltage
	Beware of explosion
	Beware of crushing
	Beware of hazardous substances
	Beware of hand injuries
	Beware of slipping
	Beware of hazard area





Symbol	Meaning
	Useful additional information and tips
	Read operation manual

2 Safety instructions and regulations

2.1 Hazard levels

The hazard level is part of the safety instructions and is denoted by the signal word.

Potential consequences are differentiated by the choice of signal word.

	Imminent danger: results in serious physical injury or death
	Potentially hazardous situation: may cause serious physical injury or death
	Potentially hazardous situation: may cause minor physical injury
	Potentially harmful situation: may cause damage to the product or other objects

2.2 Layout of safety instructions

These warning notices are depicted with warning symbols and signal words in the corresponding safety colours.





Nature and source of the hazard

Explanation on the nature and source of the hazard

- ▶ Measures for averting the hazard
- ▶ Additional measures for averting the hazard, where applicable

2.3 Basic safety instructions

2.3.1 Product safety

The machine conforms to state-of-the-art technology and the recognised safety regulations. Nonetheless, hazards may occur.

- ▶ Operate the machine only in compliance with the operation manual.
- ▶ During machine handling, observe the safety instructions and warning notices that precede each action.

All modifications and alterations to the product are reserved for persons authorised by HOBART.

GC/GCP GX/GP FX/FP

Safety instructions and regulations

2.3.2 Personnel qualification

- ▶ Observe the regulations on occupational health and safety.
- ▶ Carefully read through the Operation Manual before use.

Activity	User group	Qualification/training
Installation	Qualified personnel	Hobart Service or an electrically qualified person trained by Hobart or a competent person acc. to the German technical regulations for occupational safety (TRBS 1203) trained by Hobart
	Trainees	Only under professional supervision and examination
Commissioning	Qualified personnel	Hobart Service or an electrically qualified person trained by Hobart or a competent person acc. to the German technical regulations for occupational safety (TRBS 1203) trained by Hobart
	Trainees	Only under professional supervision and examination
Work on electrical system	Qualified personnel	Hobart Service or an electrically qualified person trained by Hobart or a competent person acc. to the German technical regulations for occupational safety (TRBS 1203) trained by Hobart
Operation	Operating personnel and persons over the age of 14	Only under supervision and after instruction by the operator on the basis of the Operation Manual, instructions on dangers
	Handicapped individuals	The suitability must be assessed by the operator on an individual basis
	Persons up to the age of 13	Persons up to the age of 13 are not suited for machine operation
Maintenance, repair	Qualified personnel	Hobart Service or an electrically qualified person trained by Hobart or a competent person acc. to the German technical regulations for occupational safety (TRBS 1203) trained by Hobart
	Trainees	Only under professional supervision and examination

2.3.3 Product-specific hazards

Avoid body parts being crushed or knocked:

- ▶ Observe the instructions on the packaging for storage, lifting or transporting.
- ▶ Do not reach into the hinge while closing the front door.
- ▶ The machine must be secured against tipping over when set up in a freestanding position.

Avoid risk of explosion:

- ▶ Do not install machine in a potentially explosive location.

Avoid electric shock, fire hazard:

- ▶ Do not allow water to flow over live components.
 - Make sure the machine does not overflow when being filled.
- ▶ Do not damage the connection cable while unpacking.
- ▶ Have the machine connected to the power supply only by qualified personnel.
- ▶ Have all modifications to the machine carried out by qualified personnel.
- ▶ Do not operate the machine without supervision.
- ▶ Disconnect the machine from the mains prior to cleaning.

Avoid chemical burns, sensitisation of the skin, poisoning:

- ▶ Wear protective equipment (gloves, safety goggles, protective clothing) when handling chemicals.
- ▶ Do not open the machine during operation, wait for the program to finish.
- ▶ Wear protective equipment (gloves, safety goggles, protective clothing) when cleaning parts contaminated by washing solution.

Avoid burns, scalds (to the hands):

- ▶ Do not open the machine during operation, wait for the program to finish. Otherwise, hot water could spray out.

Avoid slipping:

Moisture can build up on the machine floor.

- ▶ Use a suitable floor covering to prevent this from causing a slipping hazard.

2.3.4 Additional hazards

Potential hazards caused by operating resources to be used can be found in the enclosed safety datasheets. Workplaces must be marked accordingly.

2.4 Property damage**Avoid frost damage:**

Temperatures below 0°C lead to functional damage.

- ▶ Before storing below 0°C, empty residual water in hoses, tank and boiler.
- ▶ Prior to restart, store the machine at room temperature (min. 15°C) for 24h.

Avoid water damage:

- ▶ Do not operate the machine without supervision.
- ▶ Close on-site shut-off valves at the end of operation.

3 Product description**3.1 Intended purpose**

The machine is an item of technical equipment intended solely for commercial dishwashing.

The machine is designed solely for cleaning crockery (porcelain, glass, ceramic, temperature-resistant plastics or stainless steel or similar) from the food industry.

Not for washing:

- Containers that do not come into contact with foodstuffs, such as ashtrays, electric appliances etc.
- Animals or textiles
- Foodstuffs intended for further consumption

3.2 Designation

The rating plate is located on the front of the machine. If you have any questions regarding service and parts, quote the serial and DSN No.

3.3 Technical data

	GC/GCP	GXC/GPC	GX/FX/GP/FP	FXL
Dimensions (H x W x D)	705 x 460 x 590 mm	705 x 600 x 603 mm	825 x 600 x 603 mm	825 x 600 x 640 mm
Water consumption per basket	1.7 to 3.2 l*	1.8 to 4 l*	1.8 to 10.6 l*	1.8 to 10.6 l*
Voltage	see rating plate			
Total connected load				
Fuse protection				
Tank capacity	8 l	10.6 l	10.6 l	10.6 l
Loading height	315 mm	305 mm	425 mm	425 mm
Emission sound pressure level L_{pA} (measurement uncertainty $k_{pA} = 2.5$ dB)	57/58 dB (A)	PROFI: 59 dB (A)/PREMAX: 60 dB (A)		
Weight	50 kg	59 kg	60 kg	60 kg
* Depending on programme and entry of dirt/FP with 0.8 l In Eco programme				

4 Controls

4.1 Overview

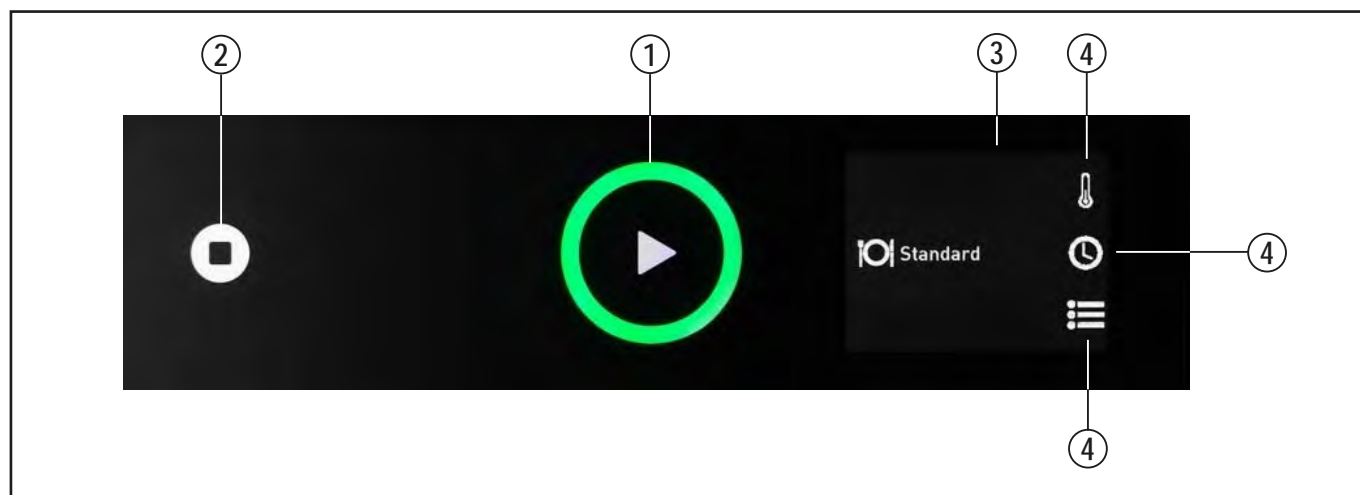



①	ON/OFF button	Tapping this button switches the machine on. As soon as the machine is ready for operation, the wash programme can be started by tapping the button. Holding the button for 3 seconds activates the automatic drain and self-cleaning cycle and switches off the machine. After switch off, however, the machine is not voltage free! The button also shows the current operating state by using different colours (see sections 7.4.1 et seq. and section 9)
②	STOP button	In case of handling errors or machine faults, this button can be used to switch off the machine immediately without prior pump out. After switch off, however, the machine is not voltage free!
③	Display	Selection menu / error and information displays

④	Display buttons	Context-specific, integrated into the touch screen and identified by symbols
---	-----------------	--

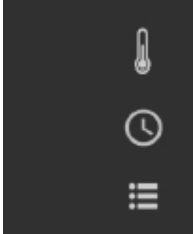
4.2 Main display functions



Tapping on the symbol enables direct access to

-  Temperature display
-  Programme selection
-  Machine/operating data and login for further settings and displays

4.3 Navigating, selecting and setting



Current settings are shown inversely. The display buttons are context-specific, used for navigation or selection and identified by symbols. Example - Make the desired selection via the Up/Down arrow symbol or the Left/Right arrow symbol or set via the +/- symbol. A selection different to the current setting is indicated by a frame. Confirm the selection by tapping the tick symbol.

The back symbol enables you to return to a previous menu level or complete a setting.



5 Installation

5.1 Personnel qualification

Installation is reserved for qualified personnel (see section 2.3.2).

5.2 Special safety instructions

CAUTION!

Risk of being crushed or knocked

When being lifted, transported and mounted on an optional substructure, the machine can overturn or fall and cause injury.

- ▶ Heed information on the packaging. Wear personal protective equipment.



NOTICE!

Temperatures below 0°C during transport/storage cause function impairments.

- ▶ Prior to installation, store the machine at room temperature (min. 15°C) for 24h.

5.3 Transporting to the installation location

- ▶ If possible transport the machine in its packaging and on the pallet.

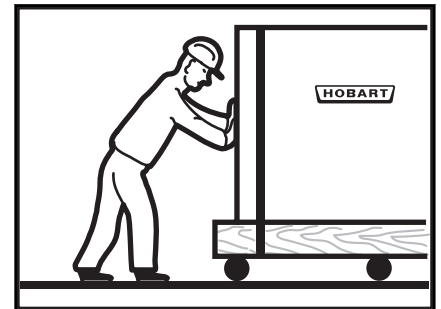

- ▶ Use suitable transport means (elevating truck, crane etc.).
- ▶ If using a forklift, shim the machine with wooden trusses.
- ▶ Secure the door to prevent opening when transporting without packaging.

5.4 Removing the packaging

⚠ CAUTION!



Risk of electric shock, fire hazard

When the machine is unpacked, the connection cable can become damaged and later cause injury from electric shock or fire.

- ▶ Do not damage the connection cable while unpacking the machine.

- ▶ Remove packaging materials and accessories from the machine.
- ▶ Inspect the machine for possible transport damage.

5.5 Installing the machine

⚠ WARNING!



Risk of electric shock, fire hazard

Water ingress can cause short circuit and mortal danger from electric shock and fire.

- ▶ Machine must be shimmed and must be accessible only from the front. Otherwise a back cover (optional) must be installed.

⚠ WARNING!



Risk of explosion

Installing the machine in a potentially explosive location can cause explosion and serious injury from ejected parts.

- ▶ Do not install machine in a potentially explosive location.

⚠ CAUTION!



Risk of body parts being crushed or knocked

The machine may tip over when set up in a freestanding position.

- ▶ The machine must be secured against tipping over when set up in a freestanding position.

Wall clearance is not required.

- ▶ Align machine horizontally with the aid of a spirit level by turning the adjustable feet until the door handle is flush with the control panel.

NOTICE!**Property damage**

Vapour may escape from the dishwasher door and lead to property damage.

- ▶ Adjacent furniture has to be protected to prevent swelling.

5.6 Connecting to the power supply

⚠ WARNING!**Risk of electric shock**

Failure to connect properly to the power supply can cause mortal danger from electric shock.

- ▶ Have the machine connected to the power supply only by qualified personnel.
- ▶ Take cable measurement DGUV V3.

NOTE: To guarantee the electrical safety of the machine, it must be connected to a protective earthing equipment conductor installed as specified. In addition, the machine must be connected on site to the equipotential bonding connection. The connecting screw (⚡) provided for this purpose is located next to the cable inlet.

These fundamental safety requirements and the professional design of the on-site installation must be verified by a qualified electrician.

Hobart does not accept any liability for damage caused by improper installation! Any applicable local installation instructions must be observed!

The mains cable must be connected via a cut-out device (main switch or accessible plug device).

Modification to an alternative power supply is possible as per the variants on the circuit diagram. Connection diagrams are located adjacent to the connection terminals.

5.7 Connecting the water

NOTE: The machine must be operated with potable water. For water with an extremely high mineral content, an external demineralisation unit is recommended.

- ▶ If possible, connect to warm water (max. 60 °C).
- ▶ Connect variants with cold rinse to cold water.

Water hardness:

- Machines without softener: max. 3 °d = 0.5 mmol/l.
- Machines with softener: max. 35 °d = 6.2 mmol/l.

Flow pressure:

- Machines without softener: flow pressure 0.5 – 10 bar.
- Machines with softener: flow pressure 0.8 – 10 bar.
- If the flow pressure > 10 bar: provide pressure reducing valve.

- ▶ Connect the union nut "A" (3/4" thread) of the water supply hose to the site shut off valve.

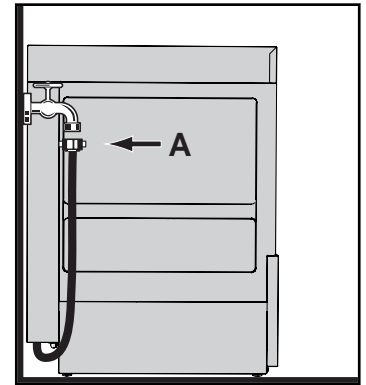

- ▶ Do not kink or cut the water supply hose.
- ▶ Any required extension must be executed using a suitable pressure hose, e.g. 324088-1.

5.8 Connecting the drain

- ▶ Connect the drain hose to a site drain.
- ▶ The connection between machine and site drain must not exceed a max. height of 0.75 m (GXC/GPC: 0.6 m).

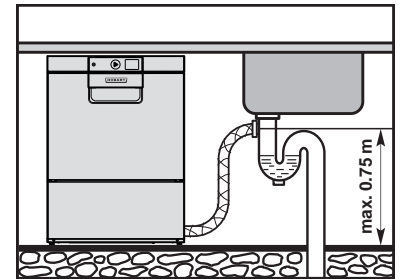

- ▶ Do not kink or lay the drain hose loose on the ground.

5.9 Retrofitting integrated chemical container (optional)

⚠ WARNING!



Risk of electric shock

When touching live parts (hot water tank heater, tank heater, pumps).

- ▶ Have mounted by qualified personnel only.

- ▶ Install according to separate installation instructions.

5.10 Retrofitting chemical suction lances with low-level sensors (optional)

⚠ WARNING!



Risk of electric shock

When touching live parts (hot water tank heater, tank heater, pumps).

- ▶ Have mounted by qualified personnel only.

- ▶ Install according to separate installation instructions.

6 Commissioning

6.1 Personnel qualification

Commissioning is reserved for qualified personnel (see section 2.3.2).

6.2 Checking the software version

Check the software version in service mode and update it if necessary.

6.3 Starting the commissioning procedure

When the machine is turned on for the first time, the commissioning procedure starts automatically with the language selection, followed by further requisite commissioning steps.

- ▶ Tap ON/OFF button.



↳ Display is activated.

↳ The **set language** menu is displayed.

6.4 Setting the language

- ▶ Select the required language using the Up/Down symbol.



- ▶ Tap the tick symbol.



↳ The language is activated.

↳ The **Set date** menu is displayed.

6.5 Setting the date

- ▶ Make settings using the Up/Down symbol.



- ▶ Use the Left/Right symbol to toggle between Day/Month/Year.



- ▶ Tap the tick symbol.



↳ The date is activated.

↳ The **Set time** menu is displayed.

GC/GCP GX/GP FX/FP

Commissioning

6.6 Setting the time

- ▶ Make settings using the Up/Down symbol.
- ▶ Use the Left/Right symbol to toggle between hours and minutes.
- ▶ Tap the tick symbol.
 - ↳ The time is activated.



6.7 Select connected load

This ensures the consumption is correctly calculated. The value must be adapted for alternative connection variants (according to information in wiring diagram).

- ▶ Set using the Up/Down symbol.
- ▶ Tap the tick symbol.
 - ↳ Selection is activated.



6.8 Setting the water hardness (optional)

On machines with integrated softener, make the water hardness setting to the local water supply.

- ▶ Set using the Up/Down symbol.
- ▶ Tap the tick symbol.
 - ↳ Water hardness is activated.



6.9 Filling the salt reservoir (optional)

On machines with integrated softener, an instruction to fill the salt reservoir appears during commissioning.

NOTICE!

Property damage

Accidentally filling the salt reservoir with detergent will damage the water softener.

- ▶ Do not fill the salt reservoir with detergent.

- ▶ Open the door.
- ▶ Unscrew the salt reservoir lid and use the funnel provided to add 1.5 kg of granular (2–8 mm) regenerating salt (do not use salt tablets).
- ▶ Fill up the reservoir with potable water (only at commissioning).
- ▶ Make sure the lid seal is free of dirt and salt.
- ▶ Screw lid back on and tighten.

NOTICE!**Property damage**

Salt residues on the tank floor cause corrosion damage.

- ▶ Remove salt residues by hand.
- ▶ Start a wash programme to remove all traces of salt if necessary.

- ▶ To continue the commissioning procedure, tap the tick symbol. 

6.10 Filling the chemical container and suction hoses

We recommend the use of HOBART Hyline detergent and rinse aid.

CAUTION: Mixing chemicals in the hose when exchanging chemicals can lead to crystallisation and damage to the hoses and dosing units. This is prevented by intermediary rinsing with water (see section 8.6). Failure to comply with this information will invalidate the guarantee and product liability.

⚠ WARNING!**Chemical burns, sensitisation of the skin, poisoning**

Incorrect handling of detergent or rinse aid can lead to serious injuries.

- ▶ Use only commercially available detergents and rinse aid (for industrial use).
- ▶ Observe the manufacturer's application and safety instructions.
- ▶ Wear protective equipment (gloves, safety goggles, protective clothing) when handling chemicals.

6.10.1 Provisioning external chemical canisters

On machines without integrated chemical container, an instruction to insert the suction hoses into external canisters appears. Suction height of dosing pump: max. 1.5 m.

- ▶ Place suction hose **without** colour marking at the suction valve down to the bottom of a detergent container.
- ▶ Place suction hose with **blue** marking at the suction valve down to the bottom of a rinse aid container.
- ▶ Tap the tick symbol. 

↳ Instruction "Close the machine door" is displayed.

- ▶ Close door and tap the tick symbol. 

↳ Suction hose filling is activated and visualised in the display by a time bar.



6.10.2 Filling integrated chemical containers (optional)

On machines with retrofitted, integrated containers, the instruction to fill the chemical containers appears.

- ▶ Open the frontal covering forwards.
- ▶ Fill the **colourless** container with **detergent** to the "MAX" mark using a funnel. Do not overfill the container!
- ▶ Fill the **blue** container with **rinse aid** to the "MAX" mark using a funnel. Do not overfill the container!



GC/GCP GX/GP FX/FP

Operation

- ▶ Tap the tick symbol. 
 - ↳ The instruction "Close the machine door" is displayed.
- ▶ Close doors and tap the tick symbol. 
 - ↳ Suction hose filling is activated and visualised in the display by a time bar.

6.11 Completing the commissioning procedure

The machine can be started or alternatively switched off.

- ▶ Tap the Up/Down symbol until the required setting is highlighted. 

- ▶ Tap the Up/Down symbol. 
 - ↳ Machine starts or switches off.

7 Operation

7.1 Personnel qualification

The machine must be operated by instructed personnel (see section 2.3.2).

7.2 Special safety instructions

CAUTION!



Chemical burns, sensitisation of the skin, poisoning, burning

If the Door is opened during operation, vapour can escape and/or wash water can spurt out and cause injury.

- ▶ Do not open the Door during operation, wait for the program to finish.

WARNING!



Danger of slipping

Moisture can build up around the machine and cause slipping.

- ▶ Provide a floor covering that is guaranteed to be non-slip in case of moisture.

7.3 Notes for optimum wash results

The rinse result is significantly affected by the water quality. The minerals dissolved in the water become visible on the washware in the form of spots and streaks during the drying process.



If the mineral content is high, we recommend the use of a HOBART HYDROLINE demineralising unit.

Before washing new glasses the first time with a commercial glass washer, intensive basic cleaning is mandatory to reduce the greasy film which is on most glasses for protection during production. We recommend this basic clean is

carried out by hand (wear gloves) with a higher detergent concentration (minimum 10 g/l) in a sink using a brush. Alternatively, the programme described in section 7.10 can also be used.

7.4 Preparations for washing

7.4.1 Preparing the machine

- ▶ Check correct position of wash/rinse arms and strainers.
- ▶ Open site shut-off valve.
- ▶ Turn on main switch or insert the plug.
- ▶ Check level of detergent and rinse aid container.
- ▶ Close the door.
- ▶ Tap the ON/OFF button.



↳ Machine is switched on.

↳ The tank is filled.

The ON/OFF button gradually turns green during the filling and heating cycle. This process can take several minutes.



When the button becomes completely green, the machine is ready for operation.

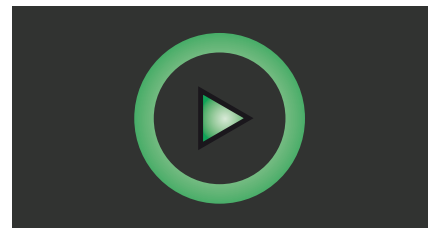

7.4.2 Preparing the washware

- ▶ Remove any food residue.
- ▶ Place wash ware face down in the rack.

NOTE: We recommend using mesh baskets for the PREMAX models GP and GPC.

7.5 Displaying and selecting the program

7.5.1 Programme overview

Programme name	Description	GC	GCP	GX	GP	FX	FP
Short	For slight dirt deposits				X		
Standard	For normal dirt deposits				X		
Intensive	For normal dirt deposits/extended rinsing			X			--
ECO	Economy programme for light to normal dirt deposits						X
Cold	For normal dirt deposits and glass cooling			X			--

Programme name	Description	GC	GCP	GX	GP	FX	FP	
E-save	Reduced energy consumption programme for light to normal dirt deposit	X						
Intensive with water exchange	For heavier dirt deposits. With tank water change	--				X		
Duration	For heavy dirt deposits	--				X		
Cutlery	For thorough cutlery cleaning	--			X		--	X
Hygiene	For machine cleaning (see 7.9)	X						
Basic cleaning	For removing stubborn deposits (see 7.10)	X						
Cold prewash	For rinsing albuminous soil deposits	optional - for FXL only						

X = Programme available

-- = Programme not available

7.5.2 Displaying and selecting the program

The standard programme is automatically selected after switching on. If necessary, a different programme can be selected.

- ▶ To display the current programme, tap the programme selection symbol before the start.

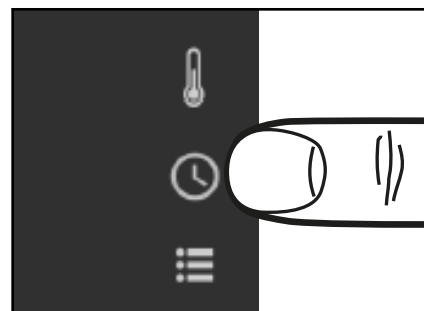

↳ The programme selection list is displayed.

↳ The programme currently selected is inversely highlighted.



- ▶ Select a different programme using the Up/Down symbol.
- ▶ Confirm with the tick symbol.
- ▶ The programme selection list can be exited without changes by tapping the back symbol.



7.6 Washing

- ▶ Slide rack into the machine and close the doors.
- ▶ Tap the ON/OFF button.
- ▶ While the programme is running, the ON/OFF button gradually changes from blue back to green.
- ▶ As soon as the ON/OFF button illuminates completely green again, the wash cycle is finished.

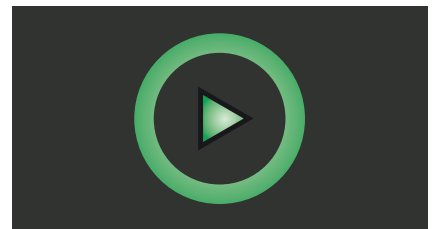

With PREMAX models, a drying and condensation process (3 minutes duration) automatically starts at the end of the wash programme. This can be interrupted at any time by opening the door.



With the GCP model, condensate can drip from above onto the door. For technical reasons, the dryer fan also switches on temporarily in stand-by-mode.

- ▶ Open the door and remove the rack.
- ▶ Allow the wash ware enough time to dry.

7.7 Switching off the machine

- ▶ Close the door.
- ▶ Push the ON/OFF button for three seconds.



↳ The machine drains the tank and cleans the machine interior. At the same time, the ON/OFF button gradually changes from green back to colourless.



↳ The machine then switches off.

When the ON/OFF button has extinguished completely:

- ▶ Turn off main switch or remove the plug.
- ▶ Close on-site shut-off valve.



If no button is pressed, the machine switches off automatically after 6 hours, but will not pump out.

GC/GCP GX/GP FX/FP

Operation

7.8 Cleaning

NOTICE!

Property damage

The use of unsuitable agents can cause corrosion or damage to the surfaces.

- ▶ Do not use any chlorine-containing, acidic or metal-containing additives to clean the machine.
- ▶ Do not use metal sponges.

7.8.1 Executing daily cleaning

- ▶ Remove sieves and clean. **Make sure that food debris does not enter pump intake!**
- ▶ Flush the fine strainer under running water.
- ▶ Clean machine areas that cannot be reached by the water circulation (door sealing, etc.).
- ▶ Replace strainer.
- ▶ Leave the door open for ventilation.
- ▶ Check the surface of the operating panel and clean if required.

7.8.2 Cleaning rinse arms

- ▶ Push and hold the clip fastener on the rinse arms, remove the rinse arms and clean.
- ▶ Replace the rinse arms.

7.9 Executing hygiene cleaning

When a pre-set number of rinse cycles has been reached, the instruction "Execute hygiene program" appears in the display, indicating that an automatic hygiene clean of the machine interior should be executed. The instruction can be suppressed for some rinse cycles by tapping the tick symbol on the display. The hygiene programme is carried out as follows:

- ▶ Before end of operation, remove the rack and place a HOBART hygiene tab in the machine interior.
- ▶ Close the door.
- ▶ Tap the programme selection symbol.
- ▶ Use the Up/Down symbol to select the hygiene programme.
- ▶ Confirm with the tick symbol.
- ▶ Tap the ON/OFF button.



- ↳ While the hygiene programme is running (duration approx. 10 minutes), the green illuminated segments extinguish successively.



- ↳ At the end of the programme, the machine switches off automatically.



If necessary, hygiene clean should be executed before the pre-set number of wash cycles is reached. With regular use, the machine interior will remain free of soil and dirt deposits.

7.10 Executing the basic cleaning program for washware

Special programme for removing stubborn coatings/deposits on wash ware (e.g. protective film on new glasses, starch residues)

CAUTION!



Chemical burns, sensitisation of the skin, poisoning

The use of unsuitable chemicals can cause injury.

- ▶ Manual addition of a special agent as recommended by your chemical supplier.
- ▶ Observe the manufacturer's application and safety instructions.

- ▶ Open the door.
- ▶ Manually remove coarse soil from tank cover.
- ▶ According to the individual dosing recommendations, add the powder quantity required for the tank content (see 3.3 to the flat side of the tank).
- ▶ Tap the programme selection symbol.
- ▶ Select the basic cleaning programme using the Up/Down symbol.



- ▶ Confirm with the tick symbol.
- ▶ Slide the loaded rack into the machine and close the door.
- ▶ Tap the ON/OFF button.



↳ While the programme is running (duration approx. 6 minutes), the ON/OFF button gradually changes from blue back to green.



As soon as the ON/OFF button illuminates green again, the rinse cycle is finished.



For each subsequent basic cleaning cycle, 4 litres of water must be added manually.

GC/GCP GX/GP FX/FP

Setting options, operating and hygiene data

7.11 Displaying the temperatures

- ▶ Tap on the Temperature symbol.

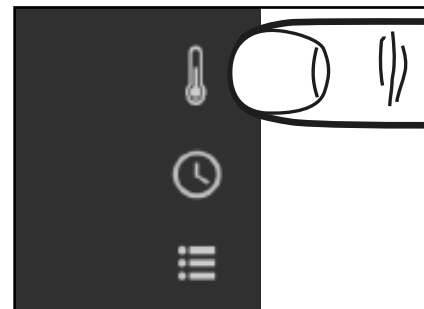

↳ The effectively reached washing and rinsing temperatures of the last wash programme are displayed.

8 Setting options, operating and hygiene data

Possible in stand-by and washing operation when the machine is switched on.

- ▶ Tap the Select menu symbol.

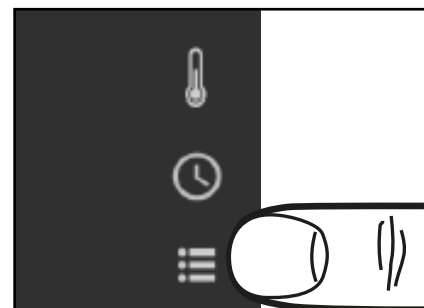

- ▶ ↳ The login and information selection is displayed.



- **Service login** gives trained technicians access to further setting options.
- The **Head login** enables the operator access to the settings and data described below.
- **Information** provides access to operating data, machines and service contact data (if saved).

For navigating, selecting and exiting in the individual menus, see section 4.3.

8.1 Information on the operation, machine and service contact data

- ▶ In the top menu level, select "Information" using the Up/Down symbol and confirm with the tick symbol.



↳ The submenu is displayed.

Submenu	Selection
Machine type	Displays machine type and serial number
Operating data	Lists the commissioning data and counter readings for operating hours, wash cycles, water and power consumption
Service addresses	Displays the saved Service contact phone numbers

8.2 Setting options and hygiene data

8.2.1 Accessing setting options and hygiene data

- ▶ Select Head login in the top menu level using the Up/Down symbol and confirm with the tick symbol.



↳ PIN input is shown.



Enter PIN code "1111":

- ▶ Set the first number using the Up/Down symbol.
- ▶ Skip to the next number via the tick symbol.
- ▶ The back symbol enables you to exit or return to the previous number.



↳ Once the code has been correctly entered, the submenus available for settings and hygiene data are displayed.

GC/GCP GX/GP FX/FP

Setting options, operating and hygiene data

8.2.2 Overview of selection menu for settings and hygiene data

Main menu	Selection
General settings	Language Date/Format Time/Format Temperature unit
Display indications	Programme representation Brightness Temperature display
Acoustic signal	On/Off
Chemical settings	Rinse aid dosing Detergent dosing Filling chemical hoses Rinse aid density Cleaner density
External water treatment	Set counter Reset counter Remaining water quantity Activate/deactivate (not for RO-I)
Degree of hardness	Setting
VAPOSTOP ² /TOP-DRY	Standard mode Silent mode
Hygiene	Hygiene programme reminder Display report Transmit report
Timer	Activate/deactivate Settings
WLAN	Activate/deactivate Status Connection wizard Request access code Connection test before access code Manual setup
Temperature level	Europe Thermolabel

8.3 Making the general settings

Submenu	Selection
Language	Languages available
Date/Format	Date setting and formats: YYYY.MM.DD DD.MM.YYYY MM.DD.YYYY
Time/Format	Time setting and format: 24h/12h
Temperature unit	°C / °F

Tapping the format symbol when setting date and time allows the display format to be changed as well.



Complete the setting by tapping the back symbol.



8.4 Set temperature display

Submenu	Selection
Permanent display	activate/deactivate
Temperature measurement	current/maximum

8.5 Setting the acoustic signal

Submenu	Selection
Acoustic signal	Sound on / sound off

8.6 Making the chemical settings

Submenu	Selection
Rinse aid dosing	Factory setting: 0.30 g/l Possible range: 0–2.0 g/l
Detergent dosing	Factory setting: 2.5 g/l Possible range: 0–9.5 g/l
Filling chemical hoses	Fill detergent dosing hose NO/YES Fill rinse aid suction hose NO/YES
Rinse aid density	Factory setting: 1 g/cm ³ Possible range: 0.9–1.5 g/cm ³
Cleaner density	Factory setting: 1 g/cm ³ Possible range: 0.9–1.5 g/cm ³

If in the **Fill chemical hoses** submenu, the prompt **Fill detergent suction hose** and/or **Fill rinse aid suction hose** are set to **Yes**, the filling process will start.

The filling process is visualised in the display by a time bar.

NOTE: The hose filling for detergent only functions when the door/hood is closed.

It can be stopped by tapping the Abort button if necessary.

8.7 Monitoring external water treatment

This allows you to monitor the capacity of an external water treatment or a pre-filter based on the water flow.

Submenu	Selection
Set counter	Determine the initial value (factory setting = 14000 litres)
Reset counter	NO YES (resets the current counter reading to the initial value)
Remaining water quantity	Displays the actual counter reading (residual capacity)
Activate/deactivate	Activates or deactivates (factory setting) the function Not an option with ROI

GC/GCP GX/GP FX/FP

Setting options, operating and hygiene data

8.8 Setting the water hardness (optional)

Submenu	Selection
Degree of hardness	Setting to the water hardness of the local water supply Factory setting: 30°dH Possible range: 0–35°dH

8.9 Setting VAPOSTOP² and TOP-DRY

Submenu	Selection
VAPOSTOP ² /TOP-DRY	Standard mode Silent mode (reduces fan noise, increases run time)

8.10 Hygiene and operating data

Submenu	Selection
Hygiene programme reminder	Activates (factory setting) or deactivates the reminder message to run a hygiene programme at the end of the preset number of cycles
Display report	
Transmit report	

The machine automatically reports all operating and hygiene-relevant events (e.g. wash programme, error messages) with their time.

The report can be either shown on the display or transmitted to a USB stick in txt format.

The reporting starts with the current date and the last event that occurred on this day. The previous events then appear.

A maximum of 1500 events are saved. Older records are overwritten.

Also listed are commissioning, temperature and dosing settings, counter readings and number of wash programmes run.

8.11 Setting the timer

Times for automatic machine switch-on and -off can be defined here.

Submenu	Selection
Activate/deactivate	Activates or deactivates (factory setting) the function
Settings	Here, a switch-on and -off time can be set individually for each week day

A small clock symbol remains in the top left-hand section of the display for 30 minutes after the machine has been activated and turned off

8.12 WLAN

Important: The functionality outside of Europe depends on the availability of a local approval for the radio module. Contact your local Hobart distributor or visit www.itwfoodequipment.com/smartconnect365/help.

Submenu	Selection
Activate / deactivate	Activates or deactivates (factory setting) the function.

Submenu	Selection
Status	Shows details of the connection (SSID of network, signal strength, channel, IP etc).
Connection wizard	Step-by-step guide to establishing a connection. Can be selected using the following options: <ul style="list-style-type: none"> – Search for network – WPS: Simplified procedure by pressing the button on the router – Add network (for hidden networks)
Request access code	Requests a new code for coupling to the Hobart app if a network connection is established.
Connection test	Tests the connection to the cloud.
Manual setup	Enables the connection to be established without step-by-step guidance by the wizard.

- Supports IEEE 802.11 b/g/n in the 2.4 GHz frequency range
- Maximum transmission capacity 19.6 dBm in the 2.4 GHz frequency range
- Encryption: WPA2-PSK / open network
- Port 443 free for communication between machine and server (default: open)
- IP address via DHCP or fixed IP address
- Connections via **Captive Portal** are not possible
- Adequate WiFi reception is required at the dishwasher's installation location
- Correct date setting required

The HOBART SmartConnect app is available for download from the App Store and the Play Store.

Web browser version at <https://hobart.smartconnect365.com>

8.13 Temperature level

Submenu	Selection
Temperature level	Europe Thermolabel

Here, it is possible to change from standard temperatures according to European DIN 10534 to elevated temperatures according to NSF (Thermolabel 71°C). As a result, the program run times are extended.

This setting is not available for the PREMAX models FP and GP(C).

9 Fault indications and problems

9.1 Fault indications

Displayed error messages are shown in the order of priority. They **must** be acknowledged with the tick symbol.

Acknowledged error messages for which the error is still pending are first hidden to enable further messages to be displayed.

If all error messages have been acknowledged but errors are still pending, these messages will then be shown again.

GC/GCP GX/GP FX/FP

Fault indications and problems

Information

- Limited operation is possible.
- The ON/OFF button illuminates green/red alternately.
- The error code is shown in the display (see table).



Error code	Message text	Action
003	Temperature not reached. Contact service technician.	Contact your HOBART Service Partner.
004	Temperature not reached. Contact service technician.	Contact your HOBART Service Partner.
008	Temperature not reached. Contact service technician.	Contact your HOBART Service Partner.
009	Temperature not reached. Contact service technician.	Contact your HOBART Service Partner.
018	Water level regulation in the wash tank.	Acknowledge, pump-out programme starts automatically.
021	Fault in the drain system. Clean the drain hose if necessary and pump-out the machine again. Contact service technician if required.	Clean the drain hose if necessary and pump-out the machine again.
022	Fault in the drain system. Clean the drain hose if necessary.	Clean the drain hose if necessary.
029	Programme aborted. Close the door.	Close the door.
034	Service interval due. Contact service technician.	Contact your HOBART Service Partner.
036	Detergent deficiency. Refill detergent.	Refill detergent (see section 6.10)
037	Rinse aid deficiency. Refill rinse aid.	Refill rinse aid (see section 6.10)
038	Input voltage too high! Machine has been switched off.	Have the input voltage checked by the (site) electrician.
039	Filling programme aborted. Close the door.	Close the door.
040	Execute hygiene programme.	Execute hygiene programme.
041	External water treatment depleted. Replace.	Replace part or full desalination cartridge.
042	Osmosis pre-filter depleted. Replace.	Replace pre-filter.
043	Salt deficiency. Refill regenerating salt.	Refill regenerating salt.
060	Fault – osmosis system in continuous operation. Contact service technician.	Contact your HOBART Service Partner.
061	Fault – osmosis system power outage. Contact service technician.	Contact your HOBART Service Partner.
062	Fault – osmosis system in standby. Contact service technician.	Contact your HOBART Service Partner.
063	Fault – osmosis system water supply pressure too low. Check water supply. Contact service technician.	Contact your HOBART Service Partner.

Error code	Message text	Action
064	Fault – osmosis system is leaking. Close water supply. Contact service technician.	Contact your HOBART Service Partner.
065	Drying function faulty. Drying wizard deactivated. Contact service technician.	Contact your HOBART Service Partner.
066	Drying function faulty. Drying wizard deactivated. Contact service technician.	Contact your HOBART Service Partner.
067	Drying function faulty. Drying wizard deactivated. Contact service technician.	Contact your HOBART Service Partner.
068	Fault – drying temperature sensor. Contact service technician.	Contact your HOBART Service Partner.
069	Fault – drying temperature sensor. Contact service technician.	Contact your HOBART Service Partner.
070	Washing temperature too low. Contact service technician	Contact your HOBART Service Partner.
071	Rinse temperature too low. Contact service technician	Contact your HOBART Service Partner.

Faults

- Limited operation is not possible.
- The ON/OFF button illuminates red permanently.
- The error code is shown in the display (see table).
- Once the error display has been acknowledged, the machine turns off.



Error code	Message text	Action
001	Fault – hot water tank temperature sensor. Contact service technician.	Contact your HOBART Service Partner.
002	Fault – hot water tank temperature sensor. Contact service technician.	Contact your HOBART Service Partner.
006	Fault – wash tank temperature sensor. Contact service technician.	Contact your HOBART Service Partner.
007	Fault – wash tank temperature sensor. Contact service technician.	Contact your HOBART Service Partner.
011	Fault – wash chamber temperature sensor. Contact service technician.	Contact your HOBART Service Partner.
012	Fault – wash chamber temperature sensor. Contact service technician.	Contact your HOBART Service Partner.
013	Disinfection not guaranteed. Contact service technician.	Contact your HOBART Service Partner.
014	Fault – hot water tank pressure sensor. Contact service technician.	Contact your HOBART Service Partner.
015	Fault – hot water tank pressure sensor. Contact service technician.	Contact your HOBART Service Partner.
016	Fault – wash tank pressure sensor. Contact service technician.	Contact your HOBART Service Partner.
017	Fault – tank pressure sensor. Contact service technician.	Contact your HOBART Service Partner.

Error code	Message text	Action
020	Fault – wash tank pressure sensor. Pump out machine and re-start.	Drain machine.
031	Check if the supply/water cock is open.	Check water supply.
032	Check if the supply/water cock is open.	Check water supply.
033	Fault in the filling system. Contact service technician.	Contact your HOBART Service Partner.
035	Insert tank cover strainer correctly.	Insert tank cover strainer correctly.
044	Salt deficiency. Refill regenerating salt.	Refill regenerating salt.
045	Number of rinse cycles without regenerating salt exceeded. Contact service technician.	Contact your HOBART Service Partner.
049	Handling faulty. Contact service technician.	Contact your HOBART Service Partner.
052	Fault in the filling or drain system. Contact service technician. Disconnect machine from the water and power supply!	Contact your HOBART Service Partner.

9.2 Remediating the problem

9.2.1 Poor wash result

Nature of the problem	Possible cause	Remedy
Wash ware not clean.	Wash arm stiff (must rotate easily by hand).	Remove wash arms and clean them thoroughly. Also check water outlet from machine to wash arm is clear.
	Wash arm nozzles are clogged (visual check).	Remove wash arm, remove cleaning caps and rinse wash arm thoroughly until all soiling is removed. Replace cleaning caps.
	Rinse nozzles clogged (usually by lime deposit).	Remove rinse arms and descale them in separate container. Check site softening system for function.
	Detergent concentration is too low or too high.	Check detergent concentration setting.
	Coarse strainer clogged.	Remove, empty and clean strainer.
	Fine strainer clogged or obstructed by lime deposits.	Remove fine strainer. If heavily soiled, soak in a vinegar solution. Then clean it thoroughly with a brush until the pores are free. The fine strainer should generally be cleaned daily (see operating instructions).
	Wrong programme selected for heavily soiled wash ware.	Select programme with longer wash cycle.
Wash ware does not dry properly.	Wash ware still greasy.	Detergent concentration too low: increase (see operation instructions). Check if detergent is appropriate. If not, choose a stronger one. Drain contaminated water and refill machine. Clear wash ware more thoroughly beforehand.

Nature of the problem	Possible cause	Remedy
	Rack is not suitable for type of dishes (sloping).	Use appropriate racks to create a sloping position which allows water to drain away from cavities.
	Wash ware remains in the machine too long at the end of wash cycle.	Remove wash ware as soon as cycle is completed to enable it to dry.
Streaks and spots on wash ware.	Hard water or high mineral content.	Check water quality. Every local water works holds data on the composition of the water they supply and will provide these on request. Reference values: Ideal calcium value: 0 – 3°d (total hardness). Ideal mineral content value: for glasses, max. conductivity 100 µS/cm, for dishes, still viable to max. 400 µS/cm.
	Rack is not suitable for type of dishes (sloping).	Use appropriate racks to create a sloping position which allows water to drain away from cavities.
	Machines with integrated softener: use of wrong salt (e.g. tablets).	Do not use salt tablets.

9.2.2 Other problems

Nature of the problem	Potential causes	Remedy
Glasses are totally or partially cloudy.	Surface of glasses is rough and porous, this is called glass corrosion.	Use new glasses, this is not caused by a malfunction on the machine.
Glass/dish breakage.	Use of unsuitable dish or glass racks.	Use suitable racks.
Machine switches off suddenly during operation.	Machine coupled to a maximum system or locked against other current consumers.	Have machine connected separately (electrician!).
	A site fuse has tripped.	Check site fuses.

10 Maintenance

In order to maintain the warranty, as well as a permanently safe, efficient, and trouble-free operation of the machine(s), the required maintenance must be carried out by authorized service technicians. We therefore recommend the conclusion of an inspection and maintenance contract, which guarantees qualified support by specially trained service technicians according to a time schedule based on the operating conditions.

Genuine spare parts must be used for repairs and wearing part replacements. Wearing parts include dosing hoses, rinse arm bearings, etc. In Germany, your HOBART machines are governed by the Ordinance on Industrial Health and Safety and must be inspected by a qualified electrician in accordance with the intervals specified by the Institute for Work and Health of the German Social Accident Insurance [DGUV V3 (BGV A3)].

11 Disposal



The machine operator is responsible for disposing of the machine and its operating materials correctly and in accordance with environmental regulations. Both national and local legal provisions and regulations must be observed!

With respect to fluorine-containing coolants in machines with heat pumps, the requirements of Regulation (EC) No. 517/2014 and supplementary national legislation must be observed in Europe.

We recommend assigning a specialist company for disposal. Alternatively, Hobart can take back the machine and its operating materials.

12 Product disclaimer

Installations and repairs carried out by non-authorized technicians or using non-genuine spare parts, and any technical alterations to the machine not approved by the manufacturer will invalidate the manufacturer's warranty and product liability.

HOBART reserves the right to make changes or improvements to its products without prior notice.

© HOBART GmbH, Offenburg 2023

13 Conformity



Original

EG-Konformitätserklärung

Declaration of Conformity / Déclaration de Conformité / Declaración de Conformidad / Dichiarazione di conformità / Conformiteitsverklaring / Deklaracja zgodności / Декларация соответствия / Uygunluk beyanı / Deklaracija o skladnosti / Izjava o skladnosti / Declaração de Conformidade / Prohlášení o shodě

Die alleinige Verantwortung für die Ausstellung dieser Konformitätserklärung trägt der Hersteller.
This declaration of conformity is issued under the sole responsibility of the manufacturer.
La présente déclaration de conformité est établie sous la seule responsabilité du fabricant.
La presente declaración de conformidad se expide bajo la exclusiva responsabilidad del fabricante.
La presente dichiarazione di conformità è rilasciata sotto la responsabilità esclusiva del fabbricante.
Deze conformiteitsverklaring wordt verstrekt onder volledige verantwoordelijkheid van de fabrikant.
Niniejsza deklaracja zgodności wydana zostaje na wyłączną odpowiedzialność producenta.
Эта декларация соответствия выдается под исключительную ответственность производителя.
Bu uygunluk beyanı, tamamen üreticinin sorumluluğu altında düzenlenmiştir.
Ova izjava o skladnosti izdaje se na isključivu odgovornost proizvođača.
Ta izjava o skladnosti je izdana na lastno odgovornost proizvajalca.
A presente declaração de conformidade é emitida sob a exclusiva responsabilidade do fabricante.
Toto prohlášení o shodě se vydává na výhradní odpovědnost výrobce.

Maschine:	Geschirrspülmaschine / Gläserpülmaschine	Hersteller / Dokumentationsbevollmächtigter:	HOBART GMBH / Verena Wiedenhöfer
Machine:	Dishwasher / Glasswasher	Manufacturer / authorized to compile the technical file:	Robert-Bosch-Straße 17
Máquina:	Machine à laver la vaisselle / Lave verres	Fabricant / autorisé à constituer le dossier technique:	77656 Offenburg / Germany
Máquina:	Lavavajillas / Lavavases	Fabricante / autorizado para unificar la información técnica:	
Máquina:	Lavastoviglie / Lavabicchieri	Fabbricante / Responsabile della documentazione:	
Machine:	Vaatswasmachine / Glazenwasmachine	Fabrikant / Geautoriseerd om de technische documentatie samen te stellen:	
Urządzenie:	Zmywarka do naczyń / Zmywarka do naczyń ze szkła	Producent / autoryzowany przedstawiciel:	
Машина:	Посудомоечная машина / Станкомоечная машина	Изготовитель / ответственный за составление документации:	
Makine:	Tezgahaltı bulaşık makinesi / Bardak yıkama	Üretici / Dokümantasyon yetkilisi:	
Stroj:	Perilica posuda / Perilica čaša	Proizvođač / ovlašten za sastavljanje tehničkog spisa:	
Stroj:	Stroj za pomivanje posode / Stroj za pomivanje kozarcev	Proizvajalec / pooblaščen za dokumentacijo:	
Máquina:	Máquina lava-loiça / Máquina lava-copos	Fabricante / Responsável pela documentação:	
Stroj:	Myčka na nádobí / Myčka na sklenice	Výrobce / osoba zplnomocněná sestavením dokumentace:	
Model:	FX - Serie	GP - Serie	Design State: FX-18-02
	FP - Serie	Care	Serial No.: 86 66 7XXXX
	FXL - Serie		

Hiermit bestätigen wir, dass die genannte Maschine entsprechend den nachfolgend aufgeführten Normen gefertigt und geprüft worden ist.
Herewith our confirmation that the named machine has been manufactured and tested in accordance with the following standards.
Par la présente, nous déclarons que la machine citée ci-dessus a été fabriquée et testée en conformité aux normes.
Por la siguiente confirmamos que la máquina mencionada ha sido fabricada conforme a las siguientes normas.
Con la presente confermiamo che la macchina indicata è stata costruita in conformità alle norme di seguito riportate.
Hierbij bevestigen wij dat de genoemde machine is gefabriceerd en getest volgens de hiervolgende voorwaarden.
Niniejszym deklarujemy, że wymieniony produkt spełnia wymogi następujących norm.
Настоящим мы подтверждаем, что указанная машина изготовлена в соответствии с приведенными ниже нормами.
İzbu belge ile belirttiğimiz makinenin aşağıda listelenen normlar doğrultusunda hazırlanmış ve test edilmiştir.
Ovime potvrđujemo da je gore navedeni stroj proizveden i testiran sukladno sljedećim standardima.
S tem izjavljamo, da je naveden stroj izdelan in preizkušen v skladu s spodaj navedenimi standardi.
Com a presente declaramos que a máquina supracitada foi construída e inspecionada segundo as normas referidas a seguir.
Timto potvrđujemo, že uvedeni stroj byl vyroben a zkontrolován podle následujících norem.

- EN 17735:2022
- EN IEC 55014-1:2021
- EN IEC 55014-2:2021
- EN 60335-2-58:2005 + Cor.:2007 + A1:2008 + A11:2010 + A2:2015 + A12:2016
- EN IEC 61000-4-3:2020
- EN IEC 61000-6-2:2019
- EN IEC 61000-6-3:2021
- EN ISO 12100:2010
- EN IEC 63000:2018

Die Maschine stimmt mit den folgenden Richtlinien überein:
The product complies with the following directives:
La machine est conforme aux directives fixées:
La máquina armoniza con las siguientes Directivas:
La macchina è conforme alle direttive seguenti:
Het product voldoet aan de volgende richtlijnen:
Urządzenie spełnia wymogi następujących dyrektyw:
Машина соответствует требованиям следующих директив:
Makine, aşağıdaki yönetmelikler ile uyumludur:
Ovaj stroj je u skladu sa sljedećim direktivama:
Stroj ustreza zahtevam sledjećih direktiv:
A máquina está em conformidade com as seguintes diretivas:
Stroj je v souladu s ustanoveními následujících směrnic:

2006/42/EG	(Maschinenrichtlinie, Machinery-Directive)
2014/30/EU	(EMV-Richtlinie, EMC-Directive)
2014/53/EU	(Funkanlagen-Richtlinie, RED)
2011/65/EU	(RoHS Richtlinie, RoHS Directive)

Die Schutzziele der Niederspannungsrichtlinie 2014/35/EU wurden gemäß Anhang I Nr. 1.5.1 der Maschinenrichtlinie 2006/42/EG eingehalten.
Protective Goals of the Low Voltage Directive 2014/35/EU are in compliance with Appendix I No 1.5.1 of the Machinery Directive 2006/42/EC.
Les objectifs de protection de la directive sur les basses tensions 2014/35/UE ont été respectés conforme à l'annexe I Nr. 1.5.1 der de la directive relative aux machines 2006/42/CE.
Directiva de protecciones de baja tension 2014/35/UE estan en acuerdo con el apéndice I No 1.5.1. de la directiva de maquinaria 2006/42/CE.
Gli obiettivi di protezione della direttiva per basse tensioni 2014/35/UE è stata rispettata secondo allegato I n. 1.5.1 della Direttiva per macchine 2006/42/CE.
De veiligheidsdoelstellingen van de laagspanningsrichtlijn 2014/35/EU zijn nageleefd in overeenstemming met nr. 1.5.1 van bijlage I van de machine richtlijn 2006/42/EG.
Produkt spełnia wymogi bezpieczeństwa dyrektywy niskonapięciowej 2014/35/UE, zgodnie z załącznikiem I nr. 1.5.1 dyrektywy maszynowej 2006/42/WE.
Цели, охраняемые Директивой по высоковольтному оборудованию 2014/35/EU, соблюдены в соответствии с приложением № 1.5.1 Директивы по машинному оборудованию 2006/42/EC.
Açık Gerilim Yönetmeliği 2014/35/EU'nin koruyucu hedeflerini, Makine Yönetmeliği 2006/42/EC, ek I no. 1.5.1'e göre uyumlandırdık.
Sigurnosni ciljevi direktive o niskom naponu 2014/35/EU udovoljavaju dodatku I br. 1.5.1. Direktive o strojevima 2006/42/EC.
Upoštevani so zaščitni cilji Direktive o nizki napetosti 2014/35/EU v skladu s priložilo I, št. 1.5.1 Direktive o strojih 2006/42/ES.
Os objetivos de proteção da Diretiva de Baixa Tensão 2014/35/UE foram cumpridos de acordo com o Apêndice I, n.º 1.5.1 da Diretiva de Máquinas 2006/42/CE.
Cile ochrany dle niskonápnévé smérnice 2014/35/EU byly splněny dle přílohy I č. 1.5.1 smérnice o strojních zařízeních 2006/42/ES.

Bestätigt durch:
Confirmed by:

Offenburg, 01.10.2023

ppa.

Harald Disch
Direktor Produktentwicklung Europa
Director Warewash Engineering Europe



Original

Declaration of Conformity

Authorized to compile the technical file:

HOBART UK
Southgate Way, Orton Southgate,
Peterborough, PE2 6GN, UK

This declaration of conformity is issued under the sole responsibility of the manufacturer.

Machine: *Dishwasher (FX/FP/FXL/Care)* Glasswasher (GX/GP)

Trade mark: HOBART

Model: FX - Serie GX - Serie Design State: FX-18-02 Serial No.: 86 66 7XXXX
FP - Serie GP - Serie
FXL - Serie Care

Herewith our confirmation that the named machine has been manufactured and tested in accordance with the following designated standards.

- BS EN 17735:2022
- BS EN IEC 55014-1:2021
- BS EN IEC 55014-2:2021
- BS EN 60335-2-58:2005+A12:2016
- BS EN IEC 61000-4-3:2020
- BS EN IEC 61000-6-2:2019
- BS EN IEC 61000-6-3:2021
- BS EN ISO 12100:2010
- BS EN IEC 63000:2018

The product complies with the following regulations:

- SI 2008/1597 (The Supply of Machinery (Safety) Regulations 2008)
- SI 2016/1091 (The Electromagnetic Compatibility Regulations 2016)
- SI 2017/1206 (The Radio Equipment Regulations 2017)
- SI 2012/3032 (The Restriction of the Use of Certain Hazardous Substances in Electrical and Electronic Equipment Regulations 2012)

Protective Goals of the Electrical Equipment (Safety) Regulations 2016 (SI 2016/1101) are in compliance with Appendix I No 1.5.1 of the Supply of Machinery (Safety) Regulations 2008 (SI 2008/1597).

Confirmed by:

Offenburg, 01.10.2023

ppa.

Harald Disch
Director Warewash Engineering Europe



Original

EG-Konformitätserklärung

Declaration of Conformity / Déclaration de Conformité / Declaración de Conformidad / Dichiarazione di conformità / Conformiteitsverklaring / Deklaracja zgodności / Декларация соответствия / Uygunluk beyanı / Deklaracja o skladności / Izjava o skladnosti / Declaração de Conformidade / Prohlášení o shodě

Die alleinige Verantwortung für die Ausstellung dieser Konformitätserklärung trägt der Hersteller.

This declaration of conformity is issued under the sole responsibility of the manufacturer.

La présente déclaration de conformité est établie sous la seule responsabilité du fabricant.

La presente declaración de conformidad se expide bajo la exclusiva responsabilidad del fabricante.

La presente dichiarazione di conformità è rilasciata sotto la responsabilità esclusiva del fabbricante.

Deze conformiteitsverklaring wordt verstrekt onder volledige verantwoordelijkheid van de fabrikant.

Niniejsza deklaracja zgodności wydana zostaje na wyłączną odpowiedzialność producenta.

Эта декларация соответствия выдается под исключительную ответственность производителя.

Bu uygunluk beyanı, tamamen üreticinin sorumluluğu altında düzenlenmiştir.

Ova izjava o skladnosti izdaje se na isključivu odgovornost proizvođača.

Ta izjava o skladnosti je izdana na lastno odgovornost proizvajalca.

A presente declaração de conformidade é emitida sob a exclusiva responsabilidade do fabricante.

Toto prohlášení o shodě se vydává na výhradní odpovědnost výrobce.

Maschine: Gläserpülmachine

Machine: Glaswasher

Machine: Lave verres

Máquina: Lavavasos

Máquina: Lavabicchieri

Machine: Glazenwasmachine

Urządzenie: Zmywarka do naczyń ze szkła

Máquina: Станомоечная машина

Máquina: Bardak yıkama

Stroj: Perilica čaša

Stroj: Stroj za pomivanje kozarcev

Máquina: Máquina lava-copos

Stroj: Myčka na sklenice

Model: GC - Serie

GCP - Serie

Hersteller / Dokumentationsbevollmächtigter:

Manufacturer / authorized to compile the technical file:

Fabricant / autorisée à constituer le dossier technique:

Fabricante / autorizado para unificar la información técnica:

Fabbricante / Responsabile della documentazione:

Fabrikant / Geautoriseerd om de technische documentatie samen te stellen:

Producent / autooryzowany przedstawiciel:

Изготовитель / ответственный за составление документации:

Üretici / Dokümantasyon yetkilisi:

Proizvođač / ovlašten za sastavljanje tehničkog spisa:

Proizvajalec / pooblaščen za dokumentacijo:

Fabricante / Responsável pela documentação:

Výrobce / osoba zplnomocněná sestavením dokumentace:

HOBART GMBH / Verena Wiedenhöfer**Robert-Bosch-Straße 17****77656 Offenburg / Germany****Design State:** GC-18-02**Serial No.:** 86 61 3XXXX**Hiermit bestätigen wir, dass die genannte Maschine entsprechend den nachfolgend aufgeführten Normen gefertigt und geprüft worden ist.**

Herewith our confirmation that the named machine has been manufactured and tested in accordance with the following standards.

Par la présente, nous déclarons que la machine citée ci-dessus a été fabriquée et testée en conformité aux normes.

Por la siguiente confirmamos que la máquina mencionada ha sido fabricada conforme a las siguientes normas.

Con la presente confermiamo che la macchina indicata è stata costruita in conformità alle norme di seguito riportate.

Hierbij bevestigen wij dat de genoemde machine is gefabriceerd en getest volgens de hiervoorgende voorwaarden.

Niniejszym deklarujemy, że wymieniony produkt spełnia wymogi następujących norm.

Настоящим мы подтверждаем, что указанная машина изготовлена в соответствии с приведенными ниже нормами.

İşbu belge ile belirttiğim makinenin aşağıda listelenen normlar doğrultusunda hazırlanmış beyan ederiz.

Ovime potvrđujemo da je gore navedeni stroj proizveden i testiran sukladno sljedećim standardima.

S tem izjavljamo, da je naveden stroj izdelan in preizkušen v skladu s spodaj navedenimi standardi.

Com a presente declaramos que a máquina supracitada foi construída e inspecionada segundo as normas referidas a seguir.

Timto potvrzujeme, že uvedený stroj byl vyroben a zkontrolován podle následujících norem.

EN 17735:2022

EN IEC 55014-1:2021

EN IEC 55014-2:2021

EN 60335-2-58:2005 + Cor.:2007 + A1:2008 + A11:2010 + A2:2015 + A12:2016

EN IEC 61000-4-3:2020

EN IEC 61000-6-2:2019

EN IEC 61000-6-3:2021

EN ISO 12100:2010

EN IEC 63000:2018

Die Maschine stimmt mit den folgenden Richtlinien überein:

The product complies with the following directives:

La machine est conforme aux directives fixées:

La máquina armoniza con las siguientes Directivas:

La macchina è conforme alle direttive seguenti:

Het product voldoet aan de volgende richtlijnen:

Urządzenie spełnia wymogi następujących dyrektyw:

Máquina соответствует требованиям следующих директив:

Máquina, aşağıdaki yönetmelikler ile uyumludur:

Ovaj stroj je u skladu sa sljedećim direktivama:

Stroj ustreza zahtevam sledećih direktiv:

A máquina está em conformidade com as seguintes directivas:

Stroj je v souladu s ustanoveními následujících směrnic:

2006/42/EG

(Maschinenrichtlinie, Machinery-Directive)

2014/30/EU

(EMV-Richtlinie, EMC-Directive)

2014/53/EU

(Funkanlagen-Richtlinie, RED)

2011/65/EU

(RoHS Richtlinie, RoHS Directive)

Die Schutzziele der Niederspannungsrichtlinie 2014/35/EU wurden gemäß Anhang I Nr. 1.5.1 der Maschinenrichtlinie 2006/42/EG eingehalten.

Protective Goals of the Low Voltage Directive 2014/35/EU are in compliance with Appendix I No 1.5.1 of the Machinery Directive 2006/42/EC.

Les objectifs de protection de la directive sur les basses tensions 2014/35/UE ont été respectés conforme à l'annexe I Nr. 1.5.1 der de la directive relative aux machines 2006/42/CE.

Directiva de protecciones de baja tensión 2014/35/UE estan en acuerdo con el apéndice I No 1.5.1 de la directiva de maquinaria 2006/42/CE.

Gli obiettivi di protezione della direttiva per basse tensioni 2014/35/UE è stata rispettata secondo allegato I n. 1.5.1 della Direttiva per macchine 2006/42/CE.

De veiligheidsdoelstellingen van de laagspanningsrichtlijn 2014/35/EU zijn nageleefd in overeenstemming met nr. 1.5.1 van bijlage I van de machine richtlijn 2006/42/ES.

Produkt spełnia wymogi bezpieczeństwa dyrektywy niskonapięciowej 2014/35/UE, zgodnie z załącznikiem I nr. 1.5.1 dyrektywy maszynowej 2006/42/WE.

Цели, охраняемые Директивой по высоковольтному оборудованию 2014/35/EU, соблюдены в соответствии с приложением № 1.5.1 Директивы по машинному оборудованию 2006/42/EC.

Alçak Gerilim Yönetmeliği 2014/35/EU'nin koruyucu hedeflerini, Makine Yönetmeliği 2006/42/EC, ek I no. 1.5.1'e göre uymuştur.

Sigurnosni ciljevi direktive o niskom naponu 2014/35/EU udovoljavaju dodatku I br. 1.5.1. Direktive o strojevima 2006/42/EC

Upoštevani so zaščitni cilji Direktive o nizki napetosti 2014/35/EU v skladu s priložilo I, št. 1.5.1 Direktive o strojih 2006/42/ES.

Os objetivos de proteção da Diretiva de Baixa Tensão 2014/35/EU foram cumpridos de acordo com o Apêndice I, n.º 1.5.1 da Diretiva de Máquinas 2006/42/CE.

Ciele ochrany die nízkonapäťovej smérnice 2014/35/EU byly splněny dle přílohy I č. 1.5.1 směrnice o strojních zařízeních 2006/42/ES.

Bestätigt durch:

Confirmed by:

Offenburg, 01.10.2023

ppa.

Harald Disch
Direktor Produktentwicklung Europa
Director Warewash Engineering Europe



Original

Declaration of Conformity

Authorized to compile the technical file:

HOBART UK
Southgate Way, Orton Southgate,
Peterborough, PE2 6GN, UK

This declaration of conformity is issued under the sole responsibility of the manufacturer.

Machine: *Glasswasher*

Trade mark: HOBART

Model: GC - Serie
GCP - Serie

Design State: GC-18-02

Serial No.: 86 61 3XXXX

Herewith our confirmation that the named machine has been manufactured and tested in accordance with the following designated standards.

- BS EN 17735:2022
- BS EN IEC 55014-1:2021
- BS EN IEC 55014-2:2021
- BS EN 60335-2-58:2005+A12:2016
- BS EN IEC 61000-4-3:2020
- BS EN IEC 61000-6-2:2019
- BS EN IEC 61000-6-3:2021
- BS EN ISO 12100:2010
- BS EN IEC 63000:2018

The product complies with the following regulations:

- SI 2008/1597 (The Supply of Machinery (Safety) Regulations 2008)
- SI 2016/1091 (The Electromagnetic Compatibility Regulations 2016)
- SI 2017/1206 (The Radio Equipment Regulations 2017)
- SI 2012/3032 (The Restriction of the Use of Certain Hazardous Substances in Electrical and Electronic Equipment Regulations 2012)

Protective Goals of the Electrical Equipment (Safety) Regulations 2016 (SI 2016/1101) are in compliance with Appendix I No 1.5.1 of the Supply of Machinery (Safety) Regulations 2008 (SI 2008/1597).

Confirmed by:

Offenburg, 01.10.2023

ppa.

Harald Disch
Director Warewash Engineering Europe

HOBART GmbH

Robert-Bosch-Str. 17
77656 Offenburg
Deutschland
Tel.: +49 (0)781.600-0
Fax: +49 (0)781.600-23 19
E-Mail: info@hobart.de
Internet: www.hobart.de

HOBART Export

Robert-Bosch-Str. 17
77656 Offenburg
Germany
Phone: +49 (0)781.600-2820
Fax: +49 (0)781.600-2819
E-Mail: info-export@hobart.de
Internet: www.hobart-export.com

Hobart UK.

Southgate Way,
Orton Southgate,
Peterborough
PE2 6GN
United Kingdom
Tel.: +44 (0)844 888 7777
Republic of Ireland: +353 (0)1246 0248
Fax: +44 (0)1733 361 347
E-mail: sales@hobartuk.com
Internet: www.hobartuk.com

Compagnie HOBART SAS

Allée du 1er mai
77183 Croissy Beaubourg
FRANCE
Tel: +33 (0)1 64 11 60 00
Fax: +33 (0)1 64 11 60 10
E-mail: contact@hobart.fr
Internet: www.hobart.fr

Hobart Nederland BV

Pompmolenlaan 12
3447 GK Woerden
Telefoon +31 (0)348 462626
Fax: +31 (0)348 430117
E-mail: info@hobartnederland.nl
Internet: www.hobartnederland.nl

Hobart Foster Belgium bvba/sprl

Industriestraat 6
1910 Kampenhout
Telefoon +32 (0) 16.60.60.40
Fax +32 (0) 16.60.59.88
E-mail: info@hobart.be
Internet: www.hobart.be

Hobart Norge

Gamle Drammenvei 120
N-1363 Høvik
Tlf.: +47-67109800
Fax.: +47-67109801
E-post: post@hobart.no
Hjemmeside: www.hobart.no

Hobart Scandinavia ApS

Håndværkerbyen 27
2670 Greve
Danmark
Tlf.: +45 4390 5012
Fax.: +45 4390 5002
E-mail: salg@hobart.dk
Internet: www.hobart.dk

Hobart Sweden/Finland

Tel: +46 8 584 50 920
E-mail: info@hobart.se
Internet: www.hobart.se

Australia

Hobart Food Equipment
Unit 1 / 2 Picken Street,
Silverwater NSW, 2128
Tel: +61 1800 462 278
Fax: +61 02 9714 0222
E-mail: sales@hobartfood.com.au
Internet: www.hobartfood.com.au

HOBART China

15th Floor, Building A
New Caohejing International Business
Center
391 Gui Ping Road
Shanghai, 200233
Telephone: +86 (0)21 34612000
Fax: +86 (0)21 34617166
Internet: www.hobartchina.com

HOBART Korea LLC

7th Floor, Woonsan Bldg, 108, Bangi-dong
Songpa-gu, Seoul 138-050
Korea
Telephone: +82 2 34 43 69 01
Fax: +82 2 34 43 69 05
E-mail: contact@hobart.co.kr
Internet: www.hobart.co.kr

HOBART (Japan) K.K.

6-16-16 Minami-Oi, Shinagawa-ku,
Tokyo 140-0013
Japan
Telephone: +81 3 5767 8670
Fax: +81 3 5767 8675
E-mail: info@hobart.co.jp
Internet: www.hobart.co.jp

Hobart International (S) Pte Ltd

158, Kallang Way, #06-03/05
Singapore 349245
Telephone: +65 6846 7117
Fax: +65 6846 0991
E-mail: enquiry@hobart.com.sg
Internet: http://www.hobart.com.sg

Hobart Thailand

43 Thai CC Tower Building,
31st FL, Room No. 310-311,
South Sathorn Rd., Yannawa,
Sathorn, Bangkok, 10120
Thailand
Telephone: +66(0)2-675-6279-81
Fax: +66(0)2-675-6282
E-mail: enquiry@hobartthailand.com
Internet: http://www.hobartthailand.com

ITW India Pvt Ltd.

501-502 Vipul Trade Centre
Sector 48 Sohna Road
Gurgaon 122001
Telephone: +91 124 4245430
Fax: +91 124 4245432