

# CATER-WASH

CW8710

## Washing Machine

OWNER'S MANUAL

Read This Manual 

Read all instructions and explanations for the installation before use. Follow the instructions carefully. Keep the operation instructions handy for later use. If the appliance is sold or passed on, ensure that the new owner always receives this operation instructions.

# CONTENTS

---

## SAFETY INSTRUCTIONS

- Safety Instructions ..... 2

## INSTALLATION

- Product Description ..... 9
- Installation ..... 10

## OPERATION

- Quick Start ..... 13
- Before Each Washing ..... 15
- Detergent Dispenser ..... 16
- Control Panel ..... 18
- Programmes..... 19
- Option..... 23

## MAINTENANCE

- Cleaning and Care ..... 27
- Trouble Shooting ..... 30
- Customer service..... 31
- Technical Specifications ..... 31
- Product Fiches ..... 32

# SAFETY INSTRUCTIONS

---

## ■ Safety Instructions

Please read the following safety information thoroughly and follow it strictly to minimize the risk of fire or explosion, electric shock and to prevent property damage, personal injury or loss of life. Failing to follow these instructions shall void any warranty.

### Warning!

This combination of symbol and signal word indicates a potentially dangerous situation which may result in death or serious injuries unless it's avoided.

### Caution!

This combination of symbol and signal word indicates a potentially dangerous situation which may result in slight or minor injuries or damage to property and the environment.

### Note!

This combination of symbol and signal word indicates a potentially dangerous situation which may result in slight or minor injuries.

### Warning!

#### ELECTRIC SHOCK HAZARD

- If the supply cord is damaged, it must be replaced by the manufacturer, its service agent or similarly qualified persons in order to avoid a hazard.
  - If the machine is damaged, it must not be operated unless repaired by the manufacturer, its service agent or similarly qualified persons.
- Risk of electric shock!

# SAFETY INSTRUCTIONS

---

- The appliance can be used by children aged from 8 years and above and persons with reduced physical, sensory or mental capabilities or lack of experience and knowledge if they have been given supervision or instruction concerning use of the appliance in a safe way and understand the hazards involved. Children shall not play with the appliance. Cleaning and user maintenance shall not be made by children without supervision.
- Children should be supervised that they do not play with the appliance.
- Children 3 years and under shall be kept away from the appliance or continuously supervised.
- Animals and children may climb into the machine. Check the machine before every operation.
- Do not climb or sit on the appliance.

## INSTALLATION LOCATION AND SURROUNDING

- All washing and additional substances are to be kept in a safe place out of the reach of children.
- Do not install the machine on a carpet floor. The obstruction of the openings by a carpet can damage the machine.
- Keep the appliance clear from heating sources and direct sunlight to avoid plastic and rubber parts to corrode.
- Do not use the appliance in humid environments or rooms containing explosive or caustic gas. In case of water leakage or water splashes let the appliance dry in the open air.
- The appliance must not be installed behind a lockable door, a sliding door or a door with a hinge on the opposite side to that of the washing machine.

# SAFETY INSTRUCTIONS

---

- Do not operate the machine in rooms with a temperature of below 5°C. This can cause damages to parts of it. If it is unavoidable, make sure to drain the water completely from the appliance after every use (see "Maintenance - Cleaning of drain pump filter") to avoid damages caused by frost.
- Never use flammable sprays or substances in the immediate proximity of the appliance.

## INSTALLATION

- Remove all packaging material and transport bolts before using the appliance. Otherwise, serious damage may result.
- This appliance is equipped with a single inlet valve and can be connected to the cold water supply only.
- Mains plug must be accessible after installation.
- Before washing clothes for the first time, the product shall be operated once throughout all the procedures without any clothes inside.
- Before using the washing machine, the product shall be calibrated.
- Do not put any excessively heavy objects on the appliance, like water containers or heating devices.
- The new hose-sets supplied with the appliance are to be used and that old hose-sets should not be reused.
- Max. Inlet water pressure 1 MPa. Min. inlet water pressure 0.05 MPa.

## ELECTRICAL CONNECTION

- Make sure the supply cable is not trapped by the machine, it can get damaged.
- Connect the product to a grounded outlet protected by a fuse complying with the values in the "Technical specifications" table. The grounding installation has to be made by a qualified electrician. Ensure that the machine is installed in accordance with the local regulations.

# SAFETY INSTRUCTIONS

---

•Water and electrical connections must be carried out by a qualified technician in accordance with the manufacturer's instructions and local safety regulations.

## Warning!

- Don't use multiple plugs or extension cords.
- The appliance must not have an external switching device such as a timer or connected to a circuit that is regularly switched on and off.
- Do not pull the plug out of the mains outlet if there is flammable gas around.
- Never pull out power plug with wet hands.
- Always pull at the plug, not at the cable.
- Always unplug the appliance if it is not being used.

## WATER CONNECTIONS

- Check the connections of the water inlet tubes, the water tap and the outlet hose for possible problems due to changes of water pressure. If the connections loosen or leak close the water tap and get it repaired. Do not use the appliance before the pipes and hoses are installed properly by qualified persons.
- Glass door may become very hot during the operation. Keep children and pets far away from the machine while it is operating.
- The water inlet and outlet hoses have to be safely installed and remain undamaged. Otherwise, water leakage can occur.
- Do not remove the drain pump filter while there is still water in the appliance. Big quantities of water can leak out, and there is a risk of scalding due to hot water.

# SAFETY INSTRUCTIONS

---

## OPERATION AND MAINTENANCE

- Never use any flammable, explosive or toxic solvents. Do not use gasoline and alcohol etc. as detergents. Only select detergents that are suitable for machine washing.
- Make sure that all pockets are emptied. Sharp and rigid items such as coins, brooches, nails, screws, stones etc. may cause serious damages to this machine.
- Remove all objects from pockets such as lighters and matches before use the appliance.
- Thoroughly rinse items that have been washed by hand.
- Items that have been soiled with substances such as cooking oil, acetone, alcohol, petrol, kerosene, spot removers, turpentine, wax and wax removers should be washed in hot with an extra amount of detergent before being dried in the appliance.
- Items containing foam rubber (latex foam), shower caps, water proof textiles, rubber backed articles and clothes or pillows fitted with foam rubber pads should not be dried in the machine
- Fabric softeners or similar products should be used as recommended in their instructions.
- Never try to open the door forcefully. The door will unlock shortly after the end of a cycle.
- Please do not close the door with excessive force. If it is found difficult to close the door, please check if the clothes are properly inserted and distributed.

# SAFETY INSTRUCTIONS

---

- Always unplug the appliance and close the water tap before cleaning and maintenance and after each use.
- Never pour water over the appliance for cleaning purpose. Risk of electric shock!
- Repairs shall only be carried out by the manufacturer, its service agent or similarly qualified persons in order to avoid a hazard. The producer will not be responsible for damages caused by the intervention of not authorized persons.

## TRANSPORT

- Before Transport:
  - Bolts shall be reinstalled to the machine by a specialized person
  - Accumulated water shall be drained out of the machine
- This appliance is heavy. Transport with care. Never hold any protruding part of the machine when lifting. The machine door cannot be used as a handle.

## INTENDED USE

The product is intended only for home use and for textiles in household amounts suitable for machine washing and drying. This appliance is for indoor use only and not intended for built in use. Only use according to these instructions. The appliance is not intended for commercial use.

Any other use is considered as improper use. The producer is not responsible for any damage or injuries that may result of it.

- This appliance is intended to be used in household and similar applications such as:
  - Staff kitchen areas in shops, offices and other working environments;
  - Farm houses;
  - By clients in hotels, motels and other residential type environments;
  - Bed and breakfast type environments;
  - Areas for communal use in blocks of flats or in launderettes.



# SAFETY INSTRUCTIONS

---

## Packaging/Old appliance



This marking indicates that this product should not be disposed with other household wastes throughout the EU. To prevent possible harm to the environment or human health from uncontrolled waste disposal, recycle it responsibly to promote the sustainable reuse of material resources. To return your used device, please use the collection systems or contact the retailer where the product was purchased. They return and can take this product for environmental safe recycling.

# INSTALLATION

## ■ Product Description

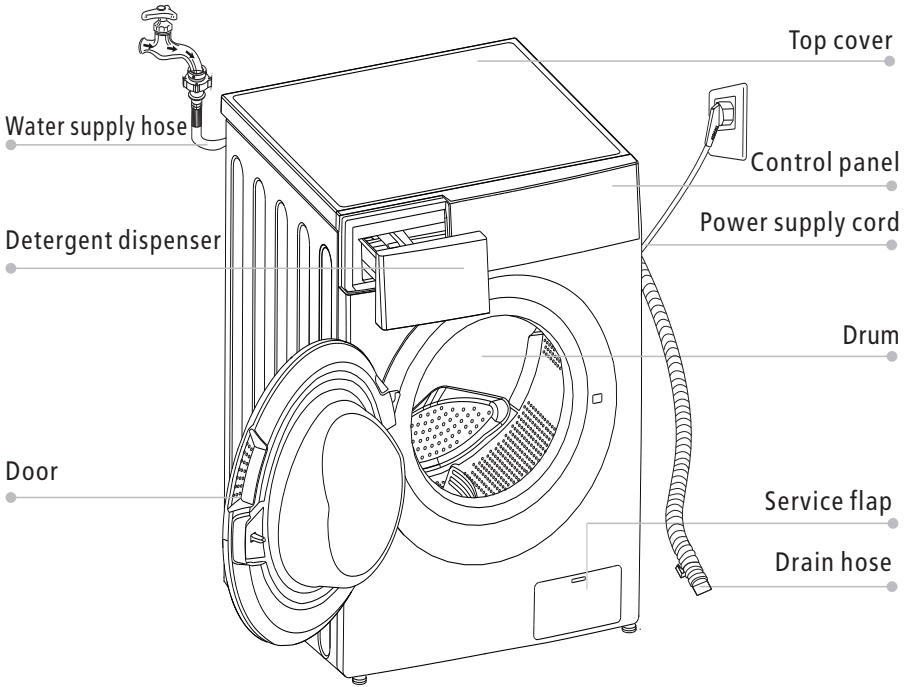

### Note!

- The product picture is for illustration only, please refer to real product as reference.

## Accessories

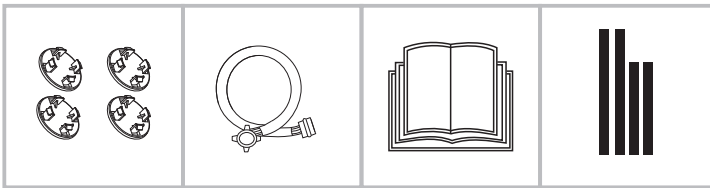

4 x Cover caps

1 x Supply hose  
cold water

1 x Owner's manual

Acoustic  
sponge  
(Optional)

# INSTALLATION

## ■ Installation

### Installation area

#### ⚠ Warning!

- Stability is important to prevent the product from wandering! Make sure the machine is standing leveled and stable.
- Make sure that the product does not stand onto the power cord.
- Make sure to maintain the minimum distances from the walls as shown in the picture

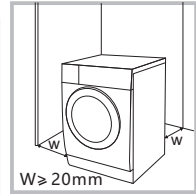

Before installing the machine, the location characterized as follows shall be selected:

1. Rigid, dry, and level surface
2. Avoid direct sunlight
3. Sufficient ventilation
4. Room temperature is above 0°C
5. Keep far away from the heat sources such as coal or gas burning appliances.

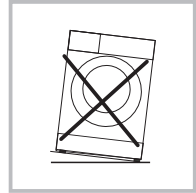

### Unpacking the washing machine

#### ⚠ Warning!

- Packaging material (e.g. Films, Styrofoam) can be dangerous for children.
- There is a risk of suffocation ! Keep all packaging well away from children.

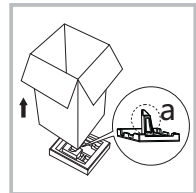

1. Remove the cardboard box and styrofoam packing.
2. Lift the washing machine and remove the base packaging. Make sure the small triangle foam (a) is removed with the bottom packaging together. If not, lay the unit down on the side surface and remove it manually.
3. Remove the tape securing the power supply cord and drain hose.
4. Remove the inlet hose from the drum.

# INSTALLATION

## Remove transport bolts

### ⚠ Warning!

- You must remove the transport bolts from the backside before using the product.



Loosen the 4 transport bolts with a spanner.

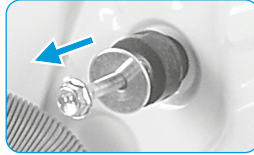

Remove the bolts including the rubber parts and keep them for future use.

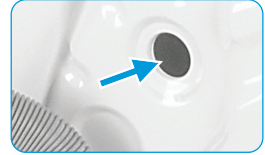

Close the holes using the cover caps.

## Levelling the washing machine

### ⚠ Warning!

- The lock nuts on all four feet must be screwed tightly against the housing.

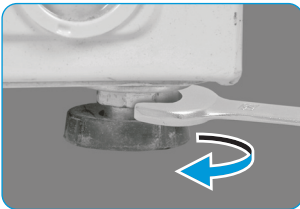

1. Loosen the lock nut.
2. Turn the foot until it reaches the floor.
3. Adjust the legs and lock the nuts with a spanner. Make sure the machine is level and steady.

## Connect the water supply hose

### ⚠ Warning!

To prevent leakage or water damage, follow the instructions in this chapter

- Do not kink, crush or modify water inlet hose.



Connect the water supply hose to the water inlet valve and a water tap with cold water as indicated.



### 🔧 Note!

- Connect manually, do not use tools. Check if the connections are tight.

# INSTALLATION

## Drain Hose

### ⚠ Warning!

- Do not kink or protract the drain hose.
- Position drain hose properly ,otherwise damage might result of water leakage.

There are two ways to place the end of drain hose:

1.Put it into the water trough.

2.Connect it to the branch drain pipe of the trough.

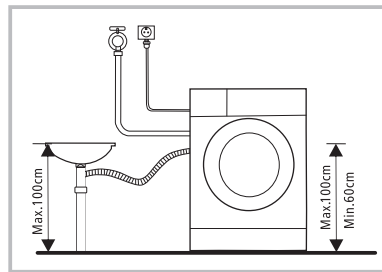
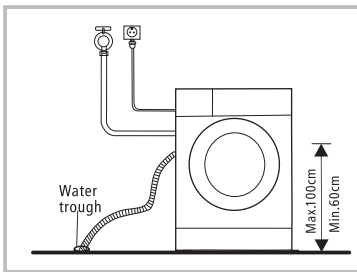

## Acoustic Sponge

### 📌 Note!

- Please make sure to assemble the acoustic sponges, which can effectively reduce the noise caused by the machine while working, in order to provide you with a more peaceful and quiet living environment.

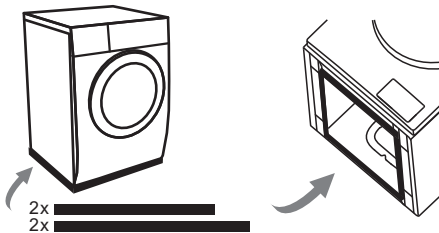

1. Get the machine laid on the floor, using some soft material like foam or clothes between the machine and floor for a protection;
2. Stick the 2x longer sponges to the longer bottom edges of machine, and the 2x shorter sponges to the shorter bottom edges.

# OPERATION

---

## ■ Quick Start

### ⚠ Caution!

- Before washing, please make sure the washing machine is installed properly.
- Your appliance was thoroughly checked before it left the factory. To remove any residual water and to neutralize potential odors, it's recommended to clean your appliance before first use. For this reason, start the Drum Clean program without laundry and detergent.

### 📌 Calibration

It's recommended to calibrate the washing machine, so that provide the best performance.

The appliance is able to detect the amount of laundry loaded. This function is optimizing the product performance by minimizing energy and water consumption, saving you money and time. For this reason it's recommended to calibrate the appliance for best use.

- 1- Remove all accessories from the drum and close the door;
- 2- Insert the mains plug to the socket;
- 3- Switch on the washing machine and press "Temp." and "Soil" simultaneously for 10 seconds until "t19" is displayed;
- 4- Press [▷||] to start the appliance and wait till "\*\*\*\*\*" is displayed.

# OPERATION

## 1. Before Washing

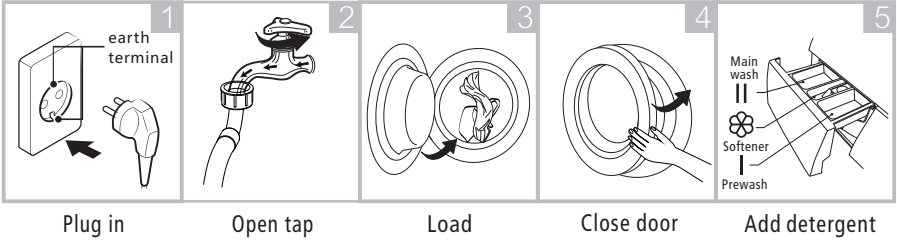

### Note!

- Detergent need to be added in compartment I if the pre-wash function is selected.

## 2. Washing

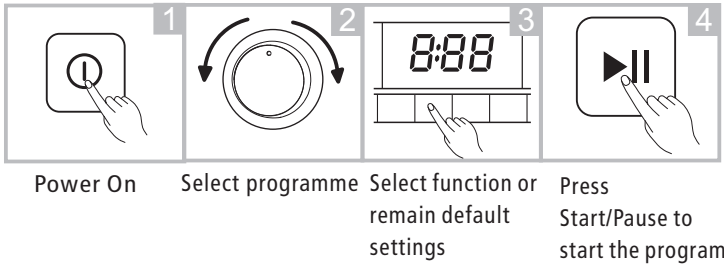

## 3. After Washing

Buzzer beep and "End" on display.

# OPERATION

## ■ Before Each Washing

- The ambient temperature of the washing machine should be 5-40°C. If used under 0°C, the inlet valve and draining system may be damaged. If the machine is installed under freezing conditions, it should be transferred to normal ambient temperature to ensure the water supply hose and drain hose can unfreeze before use.
- Please check your laundry care labels and the detergent use instructions before wash. Use non-foaming or less-foaming detergent suitable for machine washing properly.

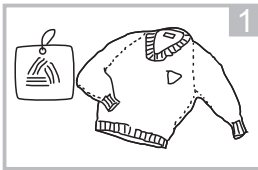

Check the care label

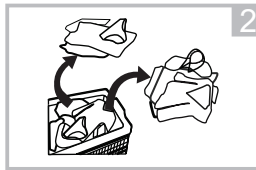

Sort laundry according to color and textile type

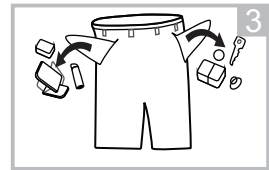

Take all items out of the pockets

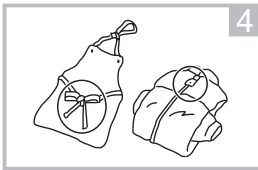

Tie together long textile strips and belts, close zips and button

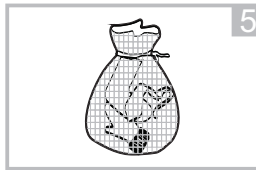

Put small items into a laundry bag

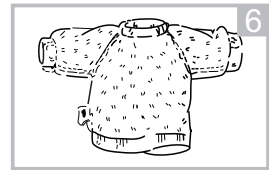

Turn easy-pilling and long-pile fabric inside out

### ⚠ Warning!

- Do not wash or dry articles that have been cleaned in, washed in, soaked in, or dabbed with combustible or explosive substances like wax, oil, paint, gasoline, alcohol, kerosene, and other flammable materials.
- Washing single clothes items may easily create big eccentricity and cause alarm due to unbalance. Therefore it is suggested to add one or two more laundry items to the wash so that spin can be done smoothly.



# OPERATION

## ■ Detergent Dispenser

- I Pre wash
- II Main wash
- ☼ Softener
- ⊖ Release button to pull out the dispenser

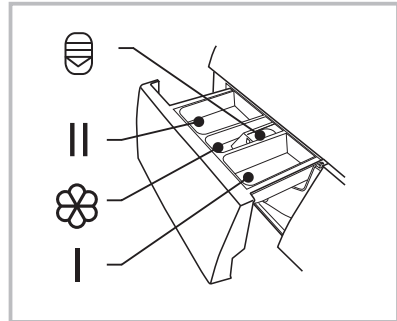

### ⚠ Caution!

- Detergent only need to be added in "compartment I "after selecting pre-wash function.

Programme	I	II / △	☼	Programme	I	II / △	☼
Cotton	○	●	○	Rinse & Spin			○
Synthetic	○	●	○	Wool		●	○
Mix	○	●	○	ECO 40-60		●	○
Bed Linen	○	●	○	Intensive		●	○
Baby Care	○	●	○	Quick 15'		●	○
20°C		●	○				
Drum Clean							
Spin Only							

- Means must
- Means optional

### 📌 Note!

- As for the agglomerated or ropy detergent or additive, before they are poured into the detergent box, it is suggested to use some water for dilution to prevent the inlet of detergent box from being blocked and overflowing while filling water.
- Please choose suitable type of detergent for the various washing temperature to get the best washing performance with less water and energy consumption.

# OPERATION

## Detergent Recommendation

Recommended washing detergent	Wash cycles	Washing temp.	Type of laundry and textile
Heavy-duty detergent with bleaching agents and optical brighteners	Cotton, ECO 40-60, Mix, Bed Linen, Intensive	40/60/90	White laundry made from boil-proof cotton or linen
Colour detergent without bleaching agent and optical brighteners	Cotton, ECO 40-60, Mix, Intensive, Bed Linen, 20°C	20/ 30/40	Coloured laundry made from cotton or linen
Color or mild detergent without optical brighteners	20°C	20/ 30/40	Coloured laundry made from easy care fibres or synthetic materials
Mild washing detergent	Synthetic	20 /30	Delicate textiles, silk, viscose
Special wool detergent	Wool	20/30/40	Wool

### Note!

- Agglomerating or ropy detergent or additive can be diluted in some water before pouring it into the detergent dispenser, to avoid its inlet to get blocked and thus cause a water overflow.
- Please choose the suitable type of detergent to get a maximum of washing performance and a minimum of water and energy consumption
- To achieve the best cleaning result a proper detergent dosing is important.
- Use a reduced detergent amount if the drum is not filled completely.
- Always adjust the amount of detergent to the water hardness, if your tap water is soft, use less detergent.
- Dose according to how dirty your laundry is, less dirty clothes require less detergent.
- Highly concentrated (compact detergent) requires particularly accurate dosing.

Following symptoms are a sign of detergent overdosing:

- heavy foam formation
- poor washing and rinsing result

Following symptoms are a sign of detergent underdosing:

- laundry turns grey
- built-up of limescale deposits on the drum, the heating element and/or the laundry

# OPERATION

## Control Panel

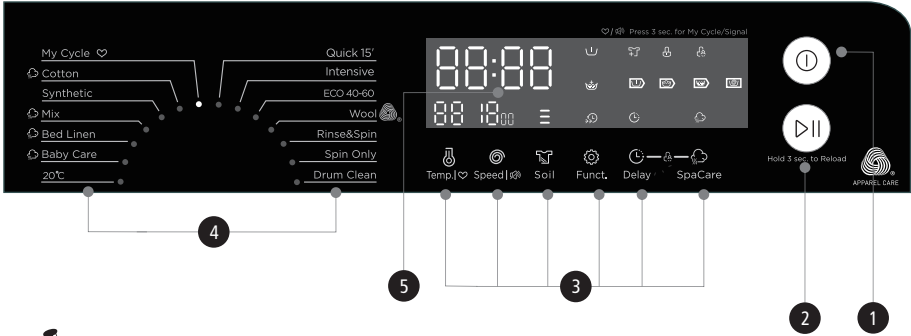

### Note!

- The chart is for reference only, Please refer to real product as standard.

#### 1 Power

Product is on/off.

#### 2 Start/Pause

Press the button to start or pause the washing cycle.

#### 3 Option

This allows you to select an additional function and will light when selected.

#### 4 Programmes

Available according to the laundry type.

#### 5 Display

The display shows the settings, estimated time remaining, options, and status messages for your washer. The display will remain on through the cycle.

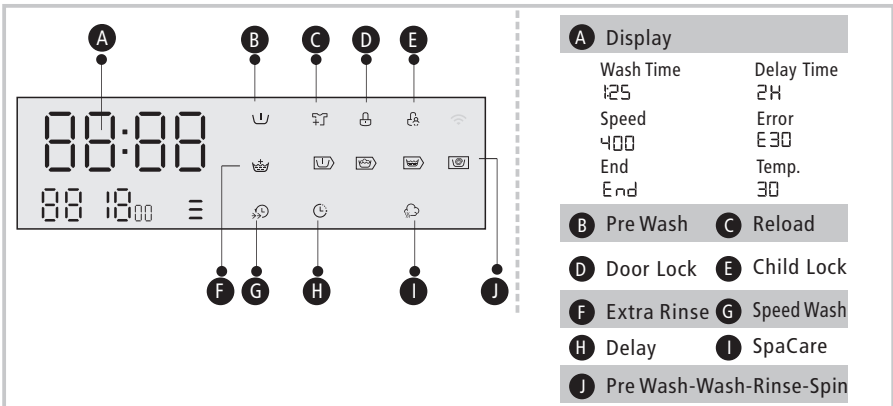

# OPERATION

---

## ■ Programmes

Model: CW8710

Programme	Load(kg)	Default Time
Cotton	10.0	3:39
Synthetic	5.0	3:18
Mix	10.0	1:20
Bed Linen	10.0	1:48
Baby Care	5.0	1:42
20°C	5.0	1:01
Drum Clean	–	1:18
Spin Only	10.0	0:12
Rinse&Spin	10.0	0:20
Wool	2.0	1:07
ECO 40-60	10.0	3:59
Intensive	10.0	3:48
Quick 15'	2.0	0:15



### Note!

- The parameters in this table are only for user's reference. The actual parameters maybe different with the parameters in above mentioned table.

# OPERATION

## ■ Programmes

Model: CW8710						
Cycle	Nominal capacity in kg	Cycle duration in hours and minutes	Energy consumption in kWh/operalling cycle	Water consumption in liter//operalling cycle	Highest temperature ature °C	residual moisiture in % /spin speed
20°C	5.0	1:01	0.25	60	20	65% / 1000
Cotton(60°C)	10.0	3:44	1.708	80	60	53% / 1500
Intensive	10.0	3:48	1.305	80	40	70% / 800
Mix	10.0	1:20	0.85	80	40	65% / 1000
Quick 15'	2.0	0:15	0.030	40	Cold	75% / 800
ECO 40-60	10.0	3:59	0.866	68.0	35	53%/1500
	5.0	3:00	0.545	53.5	30	53%/1500
	2.5	3:00	0.260	42.5	22	53%/1500

- The above data is for reference only, and the data may change due to different actual use conditions.
- The valves given for programmes other than the ECO 40-60 programme are indicative only.
- Concerning to Regulation(EU) 2019/2023,  
The EU energy efficiency class is: A  
Energy test program: ECO 40-60. Other as the default.  
Half load for 10.0kg machine:5.0kg.  
Quarter load for 10.0kg machine:2.5kg.

# OPERATION

---

- 1) The highest temperature reached by the laundry in the wash cycle for at least 5 minutes.
- 2) Residual moisture after the wash cycle in water content percent and the spin speed at which this was achieved.
- 3) The ECO 40-60 programme is able to clean normally soiled cotton laundry declared to be washable at 40°C or 60°C, together in the same cycle. This programme is used to assess the compliance with the regulation (EU) 2019/2023.

The most efficient programmes in terms of energy consumption are generally those that perform at lower temperatures and longer duration.

Loading the household washing machine up to the capacity indicated for the respective programmes will contribute to energy and water savings.

Noise and remaining moisture content are influenced by the spinning speed: the higher the spinning speed in the spinning phase, the higher the noise and the lower the remaining moisture content.

## Caution!

- If there is any break in the power supply while the machine is operating, a special memory stores the selected programme. The machine will continue the programme when the power supply is re-established.

# OPERATION

---

## ■ Programmes

Programmes are available according to the laundry type.

Programmes	
Cotton	Hard-wearing textiles, heat-resistant textiles made of cotton or linen.
Synthetic	Wash synthetic articles, for example: shirts, coats, blending. While washing the knitting textiles, detergent quantity shall be reduced due to its loose string construction and easily forming bubbles.
Baby Care	Washing the baby's clothes, it can make the baby's wear cleaner and make the rinse performance better to protect the baby skin.
Mix	Mixed load consisting of textiles made of cotton and synthetics.
Bed Linen	This program is specially designed for washing Bed Linen.
20°C	20°C default, can choose cold water.
ECO 40-60	Suitable for laundry washing at about 40°C-60°C.
Quick 15'	Extra short programme approx, suitable for lightly soiled washing as a small amounts of laundry.
Wool	Hand or machine-washable wool or richwool textiles. Especially gentle wash programme to prevent shrinkage, longer programme pauses (textiles rest in wash liquor).
Spin Only	Extra spin with selectable spin speed.
Rinse&Spin	Extra rinse with spin.
Intensive	To increase the washing effects, washing time is increased.
Drum Clean	Specially set in this machine to clean the drum and tube. It applies 90 °C high temperature sterilization to make the clothes washing more green. When this programme is performed, the clothes or other washing cannot be added. When proper amount of chlorine bleaching agent is put in, the barrel cleaning effect will be better. The customer can use this programme regularly according to the need.



APPAREL CARE

The wool wash cycle of this machine has been approved by The Woolmark Company for the washing of machine washable wool products provided that the products are washed according to the instructions on the garment label and those issued by the manufacturer of this washing machine.

CW8710

# OPERATION

## ■ Option

Cycle	Default Temp.(°C)	Default spin speed in rpm	Additional functions
Wash cycles		1500	
Cotton	40	800	🕒, 🌀, 📏, 📏, 📏, 📏
Synthetic	40	800	🕒, 📏, 📏, 📏
Mix	40	800	🕒, 🌀, 📏, 📏, 📏, 📏
Bed Linen	40	1000	🕒, 🌀, 📏, 📏, 📏, 📏
Baby Care	60	1000	🕒, 🌀, 📏, 📏, 📏, 📏
20°C	20	1000	🕒, 📏, 📏
Drum Clean	90	--	🕒
Spin Only	--	1000	🕒
Rinse&Spin	--	1000	🕒, 📏
Wool	40	600	🕒, 📏
ECO 40-60	--	1500	🕒
Intensive	40	800	🕒, 📏
Quick 15'	Cold	800	🕒

### 📌 Note!

- For the maximum spin speed, program time, and other details of the ECO 40-60 program, please refer to the content on the Product Fiche page.
- The table shows which cycle offers which options for adjustment. If an adjustment is not possible for a cycle.



# OPERATION

---

## ■ Option

Delay

### Delay

Set the Delay function:

1. Select a programme; 2. Press the Delay button to choose the time (the delaying time is 0-24 H.);
3. Press [Start/Pause] to commence the delay operation



Choose the Programme

Setting time

Start

Cancel the Delay function:

Press the [Delay] button until the display be 0H. It should be pressed before starting the programme. If the programme already started, should switch off programme to reset a new one.

---

Soil

### Soil Level

The washing time will increase or decrease after you select it.

---

## ! Caution!

- If there is any break in the power supply while the machine is operating, a special memory stores the selected programme and when the power is restarted, the program will continue.
- 

Pre Wash

### Pre Wash

The Prewash function can get an extra wash before main wash, it is suitable for washing the dust rises to surface of the clothes; You need to put detergent into the Case (I) when select it.

---

Extra Rinse

### Extra Rinse

The laundry will undergo extra rinse once after you select it.

---

Speed Wash

### Speed Wash

The function can decrease the washing time.

---



### My Cycle

To memory the frequently used programme.

After choosing the programme and setting the options, press [Temp.] 3 sec. before start to wash. The default setting course is Cotton.

---

Temp.

### Temp.

Press the button to regulate the temperature (Cold, 20°C, 30°C, 40°C, 60°C, 90°C)

---

Speed

### Speed

Press the button to change the speed.

1400: 0-400-600-800-1000-1200-1400      1500: 0-400-600-800-1000-1200-1400-1500

---

# OPERATION

---



## Reload

This operation can be executed during the washing progress. When the drum is still rolling and there is large amount of water with high temperature in the drum. The state is unsafe and the door cannot be opened forcefully. To press [Start/Pause] for 3 sec. to reload, and start the clothes adding in the midway function. Please follow the steps as bellow:

- 1.Wait until the drum stops rotation.
- 2.The door lock is unlocked.
- 3.Close the door when the clothes are reloaded and press the [Start/Pause] button.



Press[Start/Pause]3sec.



Reload the clothes

Start

SpaCare

## SpaCare

SpaCare function can be selected by choose "Cotton", "Mix" "Bed Linen" and "Baby Care".

The customers can see the steam in the drum when operate SpaCare function. The SpaCare cannot be used simultaneously With Pre Wash and Speed Wash.

### ! Caution!

- Don't use the Reload function when the water level over the edge of the inner tub or the temperature is higher.

# OPERATION

---



## Child Lock

To avoid mis operation by children.



Press [Delay] and [SpaCare]  
3 sec. till buzzer beep.

## ⚠ Caution!

When child lock is activated and program starts, child lock indicator will switch on, "CL" and remaining time on the display are alternately displayed.

Press the other buttons will make child lock indicator flash. when program finish, "CL" and "End" alternate on the display.

- Only press and hold the two button can release child lock, even power off, switch off and program end.
- The "Child Lock" will lock all buttons except Power button and Child Lock button.
- Please release child lock before selecting program and starting washing.



## Mute the buzzer



Choose the Programme



Press the [Speed]button for 3sec.,  
the buzzer is mute.

To act the buzzer function, press the button again for 3 seconds. The setting will be kept until the next reset.

## ⚠ Caution!

- After Muting the buzzer function, the sounds will not be activated any more.

# MAINTENANCE

---

## ■ Cleaning and Care

### ⚠ Warning!

- Always unplug the appliance and close the water tap before cleaning and maintenance.

### Cleaning the Cabinet

Proper maintenance on the washing machine can extend its working life. The surface can be cleaned with diluted non-abrasive neutral detergents when necessary. If there is any water overflow, use a cloth to wipe it off immediately. Never use sharp items to clean the appliance.

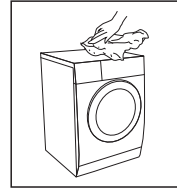

### ⚠ Caution!

- Never use abrasive or caustic agents, formic acids or its diluted solvents or similar substances, like alcohol or chemical products.

### Cleaning the Drum

Any rust stains left inside the drum by metal articles must be removed immediately using chlorine-free detergents. Never use steel wool for cleaning the drum!

### 📌 Note!

- Keep any laundry away from the machine while cleaning the drum.

### Cleaning the Door Seal and Glass

Wipe the glass and seal after each wash to remove lint and stains. If lint builds up it can cause leakages.

Remove any coins, buttons and other objects from the seal after each wash.

Clean the Door Seal and Glass every month to ensure the normal operation of the appliance.

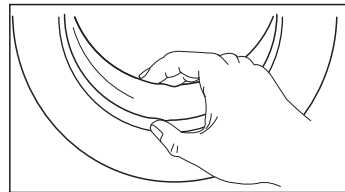

# MAINTENANCE

## Cleaning the Inlet Filter

### Note!

- Diminishing water flow is a sign that the filter need to be cleaned.

1. Close the tap and remove the water supply hose from it.
2. Clean the filter with a brush.
3. Unscrew the water supply hose from the backside of the machine. Pull out the filter with long nose pliers.
4. Use a brush to clean the filter.
5. Reinstall the filter to the water inlet and reconnect the water supply hose.
6. Clean the Inlet filter every 3 months to ensure the normal operation of the appliance.

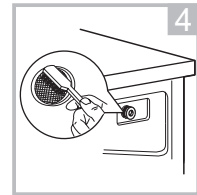
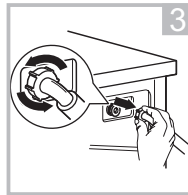
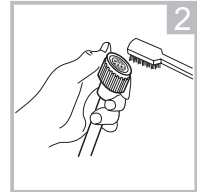
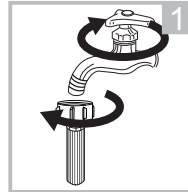

## Clean The Detergent Dispenser

1. Press down the release [  ] on the softener cover and pull the dispenser drawer out of the recess. Clean the inside of the recess with a brush.
2. Lift the softener cover off the dispenser drawer and wash both items with water.
3. Restore the softener cover and push the drawer back into the recess.

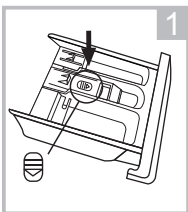

Press the release and remove the dispenser drawer

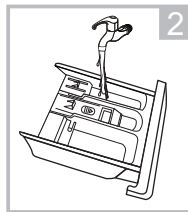

Clean the dispenser drawer and the softener cover under water

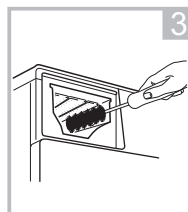

Clean the recess with an soft brush

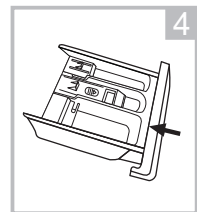

Insert the dispenser drawer

### Note!

- Do not use abrasive or caustic agents to clean plastic parts.
- Clean the detergent dispenser every 3 months to ensure the normal operation of the appliance.

# MAINTENANCE

## Cleaning the Drain Pump Filter

### ⚠ Warning!

- Make sure that the machine has finished the washing cycle and is empty. Switch it off and unplug it before cleaning the drain pump filter.
- Be careful of hot water. Allow the water to cool down. Risk of scalding!
- Clean the filter periodically every 3 months to ensure the normal operation of the appliance.

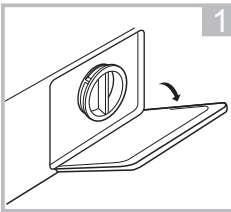

Open the lower cover cap

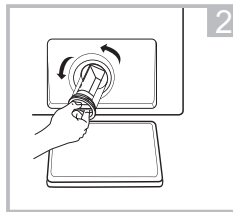

Open the filter by turning to the counter clockwise

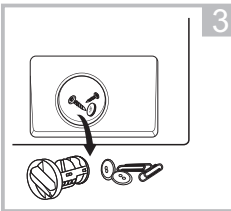

Remove extraneous matter

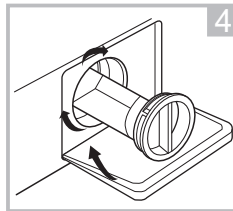

Close the lower cover cap

### ⚠ Caution!

- When the appliance is in use and depending on the programme selected there can be hot water in the pump. Never remove the pump cover during a wash cycle, always wait until the appliance has finished the cycle, and is empty. When replacing the cover, ensure it is securely re-tightened.

# MAINTENANCE

---

## ■ Trouble Shooting

Whenever there is a problem with the appliance, check if you can solve it following the tables below. If the problem persists, please contact the customer service.

Description	Possible cause	Solution
Appliance does not start	Door is not closed properly. Clothes are stuck.	Close the door properly and restart. Check the laundry.
Door can't be opened	Safety protection is activated.	Disconnect the power and restart.
Water leakage	Connections are not tight enough.	Check and fasten the water inlet pipe. Check and clean the outlet hose.
Detergent residues in the detergent dispenser	Detergent is damp and/or clotted.	Clean and wipe the detergent dispenser dry.
Indicator or display does not work	PC board or harness have connection problems.	Switch off the power and check if the mains plug is connected properly.
Abnormal noise	Fixing bolts still in place. Floor is not solid or level.	Check if the fixing bolts have been removed Make sure the appliance is installed on a solid and level floor.

## Error Codes

Description	Possible cause	Solution
<b>E30</b>	Door is not closed properly	Close the door properly and restart.
<b>E10</b>	Water injecting problem during wash cycle.	Check if the water pressure is high enough. Straighten the water pipe. Clean the inlet valve filter.
<b>E21</b>	Overtime water draining	Check the drain hose for blockage.
<b>E12</b>	Water overflow	Restart the appliance.
<b>EXX</b>	Others	Restart the appliance. If problem persists, please contact the customer service.

---

# MAINTENANCE

## Customer service

Spare part for your appliance are available for a minimum of 10 years.  
In case of questions please contact our customer service.

### Warning!

Risk of electric shock

- Never try repair an appliance which is defective or presumed to be defective. You may put your own and future users' lives in danger. Only authorised specialists are allowed to carry out this repair work.
- Improper repair will void the warranty and subsequent damages can't be recognized!

## Transport

### IMPORTANT STEPS WHEN MOVING THE APPLIANCE

- Unplug the appliance and close the water inlet tap.
- Check, if the door and the detergent dispenser are closed properly.
- Remove the water inlet pipe and the outlet hose from the house installations.
- Let the water drain completely from the appliance (see "Maintenance Cleaning the drain pump filter")
- Important: Re-install the 4 transport bolts in the back of the appliance.
- This appliance is heavy. Transport with care. Never hold any protruding part of the machine when lifting. The machine door cannot be used as a handle.

## Technical Specifications

Power Supply 220-240V~,50Hz

MAX.Current 10A

Standard Water Pressure 0.05MPa~1MPa

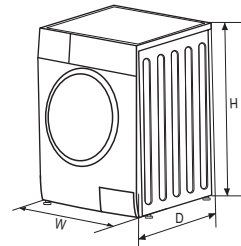

Model	Washing Capacity	Dimension (W*D*Hmm)	Net Weight	Rated Power
CW8710	10.0kg	595*565*850	70kg	1950W



# MAINTENANCE

**Supplier's name or trade mark<sup>(a)</sup>(<sup>†</sup>):** Caterkwik

**Supplier's address<sup>(a)</sup>(<sup>†</sup>):** The Lakeland Catering Centre, Newland, Ulverston, Cumbria, LA12 7QQ

**Model identifier<sup>(a)</sup>:** CW8710

**General product parameters:**

Parameter	Value		Parameter	Value	
Rated capacity <sup>(b)</sup> (kg)	10.0		Dimensions in cm <sup>(c)</sup> , ( <sup>‡</sup> )	Height	85
				Width	60
				Depth	57
Energy efficiency index <sup>(b)</sup> (EEI <sub>W</sub> )	51.9		Energy efficiency class <sup>(b)</sup>	A <sup>(d)</sup>	
Washing efficiency index <sup>(b)</sup>	1.031		Rinsing effectiveness (g/kg) <sup>(b)</sup>	5.0	
Energy consumption in kWh per cycle, based on the eco 40-60 programme. Actual energy consumption will depend on how the appliance is used.	0.513		Water consumption in litre per cycle, based on the eco 40-60 programme. Actual water consumption will depend on how the appliance is used and on the hardness of the water.	53	
Maximum temperature inside the treated textile <sup>(b)</sup> (°C)	Rated capacity	35	Weighted remaining moisture content <sup>(b)</sup> (%)	53.9	
	Half	30			
	Quarter	22			
Spin speed <sup>(b)</sup> (rpm)	Rated capacity	1450	Spin-drying efficiency class <sup>(b)</sup>	B <sup>(d)</sup>	
	Half	1450			
	Quarter	1450			
Programme duration <sup>(b)</sup> (h:min)	Rated capacity	3:59	Type	free-standing	
	Half	3:00			
	Quarter	3:00			
Airborne acoustical noise emissions in the spinning phase <sup>(b)</sup> (dB(A) re 1 pW)	80		Airborne acoustical noise emission class <sup>(b)</sup> (spinning phase)	C <sup>(d)</sup>	
Off-mode (W) (if applicable)	0.50		Standby mode (W) (if applicable)	N/A	
Delay start (W) (if applicable)	4.00		Networked standby (W) (if applicable)	N/A	

**Minimum duration of the guarantee offered by the supplier <sup>(a)</sup>(<sup>†</sup>):**

<b>This product has been designed to release silver ions during the washing cycle</b>	NO
---	----

**Additional information:**

Weblink to the supplier's website, where the information in point 9 of Annex II to Commission Regulation (EU) 2019/2023 (1) is found:

<sup>(†)</sup> this item shall not be considered relevant for the purposes of Article 2(6) of Regulation (EU) 2017/1369.

<sup>(b)</sup> for the eco 40-60 programme.

<sup>(c)</sup> changes to this item shall not be considered relevant for the purposes of paragraph 4 of Article 4 of Regulation (EU) 2017/1369.

<sup>(d)</sup> if the product database automatically generates the definitive content of this cell, the supplier shall not enter these data.

# MAINTENANCE

---

- 1) The actual energy consumption will depend on how the appliance is used.
- 2) The actual water consumption will depend on how the appliance is used and on the hardness of the water.
- 3) Delivery of the spare parts within 15 working days after having received the order.

## Product Data Sheet concerning (EU) 2019/2014

The product data sheet for your appliance can be found online.

Go to <https://eprel.ec.europa.eu> and enter the model identifier for your appliance to download the data sheet.

The model identifier for your appliance can be found in the technical specifications section.

CATER-WASH  
Tel: 01229 480001  
[www.caterwash.com](http://www.caterwash.com)