

W10251146B



SERVICE MANUAL

**Maytag Commercial
High Efficiency Single Load
Gas and Electric Dryers
50Hz Models**



* PN model converted to PR

MODELS:

**MDE22PD, MDG22PD, MDE22PN, MDG22PN
MDE25PD, MDG25PD, MDE25PN, MDG25PN
MDE28PD, MDE28PN, MDG28PD, MDG28PN**

TECHNICAL EDUCATION

FORWARD

This Maytag Service Manual, "High Efficiency Single Load Gas and Electric Dryers 50Hz Models" (Part No. W10251146B), provides the Commercial Laundry Service Professional with information on the installation, operation, and service of the High Efficiency model 22 & 25 dryers. For specific information on the model being serviced, refer to the "Installation Instructions," or "Tech Sheet" provided with the dryer. The Wiring Diagrams used in this Service Manual are typical and should be used for training purposes only. Always use the Wiring Diagram supplied with the dryer when servicing.

GOALS AND OBJECTIVES

The goal of this Service Manual is to provide information that will enable the Commercial Laundry Service Professional to properly diagnose malfunctions and repair the High Efficiency Single Load Gas and Electric Dryers. The objectives of this Service Manual are to:

- Understand and follow proper safety messages.
- Successfully diagnose installation related problems.
- Successfully troubleshoot and diagnose malfunctions.
- Successfully perform necessary repairs.
- Successfully return the dryer to its proper operational status.

WHIRLPOOL CORPORATION assumes no responsibility
for any repairs made on our products by anyone other than
authorized Commercial Laundry Service Professionals.

Copyright © 2011, Whirlpool Corporation, Benton Harbor, MI 49022

TABLE OF CONTENTS		Page
View equipment & safety video.....		vi
GENERAL.....		1-1
Model number designations.....		1-2
Serial number designations		1-2
Model & serial number label and tech sheet location		1-3
Warranty		1-4
General user information		1-5
End of set-up procedures		1-11
Maytag commercial laundry literature list		
High Efficiency product.....		1-12
INSTALLATION INFORMATION.....		2-1
Tools and parts		2-1
Location requirements		2-2
Venting requirements.....		2-3
Gas pipe chart (Natural gas).....		2-6
THEORY OF OPERATION.....		3-1
Starting the dryer		3-1
Air intake and exhaust		3-2
Typical cycle of operation		3-3
Understanding the gas valve and ignition system		3-5
Cleaning the dryer location		3-6
Cleaning the lint screen		3-6
Cleaning the dryer interior		3-7
Removing accumulated lint.....		3-7
Vacation and moving care		3-7
Dryer gas specs.....		3-8
COMPONENT ACCESS		4-1
Remove facia and display lens - Model 22		4-2
Remove control panel cover		4-3
Open dryer top.....		4-3
Remove control panel.....		4-4
Remove keypad assembly.....		4-5
Remove user interface control board (UIC).....		4-6
Remove CCU mounting bracket.....		4-7
Remove UIC & step-down transformers		4-8
Remove central control unit (CCU).....		4-9
Remove control panel bracket.....		4-10
Remove dryer top		4-11
Remove dryer door		4-12
Reverse dryer door		4-13
Remove door handle		4-15
Remove inner door support		4-15

	Page
Remove drum light lens	4-16
Remove service panel	4-16
Remove front panel	4-17
Remove lint filter housing	4-18
Remove front bulkhead.....	4-18
Remove outlet grill	4-19
Remove drum support rollers and shafts.....	4-20
Remove drum baffle	4-21
Remove dryer drum	4-22
Remove blower wheel	4-23
Remove thermistor	4-24
Remove thermal fuse.....	4-24
Remove blower housing	4-25
Remove broken belt switch.....	4-25
Remove exhaust duct.....	4-26
Remove dryer motor	4-27
Remove motor bracket	4-28
Remove idler assembly parts	4-29
Remove drum rear support rollers	4-30
Remove rear support roller shafts	4-30
Remove rear panel	4-31
Remove dryer side panel (left side shown).....	4-32
Remove rear bulkhead	4-33
Remove heat plenum.....	4-33
Remove metercase.....	4-34
Remove metercase mounting brackets	4-35
Remove service access switch - PD model.....	4-35
Remove coin vault switch - PD model	4-36
Remove coin drop - PD model.....	4-37
Remove flame sensor.....	4-38
Remove high temp thermostat.....	4-38
Remove high temp cutout.....	4-39
Remove ignitor.....	4-39
Remove auto transformer - gas dryers	4-40
Remove gas valve coils	4-41
Remove gas valve assembly	4-42
Remove gas valve from bracket	4-43
Remove electric heating element	4-44
Remove heater coil.....	4-45
Remove 180° opening door and hinge	4-46
Remove control panel cover and snap-in display lens	4-47

	Page
COMPONENT TESTING	5-1
Gas valve coils.....	5-1
Burner ignitor	5-2
Manometers.....	5-2
Flame sensor	5-4
High temp thermostat & High temp cutout (gas dryers).....	5-4
Heating element (electric dryers)	5-5
High temp cutout.....	5-6
(electric dryers)	5-6
Centrifugal switch	5-7
Drive motor	5-8
Thermistor.....	5-9
Thermal fuse.....	5-10
User interface membrane switch	5-11
UIC transformer	5-12
Step-down transformer - Model 22 dryers	5-13
Auto transformer - gas dryers	5-14
Coin drop acceptor	5-15
DIAGNOSIS & TROUBLESHOOTING	6-1
Proper Earthing of 240 volt wall outlets	6-1
Diagnostic codes	6-1
Troubleshooting guide	6-2
Troubleshooting tests.....	6-3
Troubleshooting dryer operation.....	6-11
Troubleshooting dryer results	6-13
Diagnostic mode	6-15
Dryer help mode	6-15
Central control unit (CCU) connections	6-16
User interface control (UIC) connections.....	6-16
WIRING DIAGRAMS	7-1
Model 22 PD electric models	7-1
Model 22 PD gas models.....	7-1
Model 22 PN electric models	7-2
Model 22 PN gas models.....	7-2
Model 25 PD gas models.....	7-3
Model 25 PD electric models	7-3
Model 25 PN gas models.....	7-4
Model 25 PN electric models	7-4

INTERACTIVE FLIPBOOK SERVICE MANUAL INSTRUCTIONS

View Flipbooks in the browser of PC, MAC, iPad, iPhone and Android devices.

Turn pages by dragging corner, clicking page shadow, scrolling mouse wheel, arrow keys, etc.

Click on any topic in the Table of Contents to go directly to that section.

Click on any link that says (See page ?-?) to go directly to the page referenced.

Double-click anywhere in a page to zoom in. Double-click again to zoom out.

Click  to view video. Click  for full screen video. Click  to close video.

Click  in the top left corner for Search, Print & Settings for sound on or off.

Click  in the top right corner for thumbnail view of all pages.

Click  at bottom of page for Search. Search the entire document for all instances of keyword.

Click  at bottom of page for navigation including: first, previous, by page number, next, last.

Click  at bottom of page to turn on AutoFlip to advance pages automatically every 9 seconds.

Click to View Equipment & Safety Video

GENERAL

DRYER SAFETY

Your safety and the safety of others are very important.

We have provided many important safety messages in this manual and on your appliance. Always read and obey all safety messages.



This is the safety alert symbol.

This symbol alerts you to potential hazards that can kill or hurt you and others.

All safety messages will follow the safety alert symbol and either the word "DANGER" or "WARNING." These words mean:



You can be killed or seriously injured if you don't immediately follow instructions.



You can be killed or seriously injured if you don't follow instructions.

All safety messages will tell you what the potential hazard is, tell you how to reduce the chance of injury, and tell you what can happen if the instructions are not followed.

IMPORTANT Electrostatic Discharge (ESD) Sensitive Electronics

ESD problems are present everywhere. ESD may damage or weaken the electronic control assembly. The new control assembly may appear to work well after repair is finished, but failure may occur at a later date due to ESD stress.

- Use an anti-static wrist strap. Connect wrist strap to green Earth connection point or unpainted metal in the appliance

-OR-

Touch your finger repeatedly to a green Earth connection point or unpainted metal in the appliance.

- Before removing the part from its package, touch the anti-static bag to a green Earth connection point or unpainted metal in the appliance.
- Avoid touching electronic parts or terminal contacts; handle electronic control assembly by edges only.
- When repackaging failed electronic control assembly in anti-static bag, observe above instructions.

MODEL NUMBER DESIGNATIONS

MODEL NUMBER	M	DG	25	P	A	G	W	0
BRAND M Maytag								
DRIVE TYPE DG Automatic Dryer Gas DE Automatic Dryer Electric								
PRODUCT 22 Commercial HE Dryer 25 /28 Commercial HE Dryer								
PAYMENT TYPE PD Processor Coindrop PN Processor Non-coin								
MARKETING CODE A First series B Second series								
VOLTAGE CODE W 120V-60Hz (US) X 120V-60Hz (Canada) G 220-240V-50Hz (Export Models)								
COLOR W White								
ENGINEERING CHANGE (NUMERIC)								

SERIAL NUMBER DESIGNATIONS

SERIAL NUMBER	HL	W	35	10901
DIVISION RESPONSIBILITY M Marion, Ohio HL Monterrey, MX				
YEAR OF PRODUCTION W = 2008 2 = 2012 Y = 2009 3 = 2013 0 = 2010 4 = 2014 1 = 2011 5 = 2015				
WEEK OF PRODUCTION 35 35th Week in the calendar year				
MANUFACTURING SEQUENCE NUMBER				

MODEL & SERIAL NUMBER LABEL AND TECH SHEET LOCATION

Location of Model & Serial Number Label



Location of Tech Sheet, Parts List & Wiring Diagram
Inside The Service Panel



WARRANTY

MAYTAG COMMERCIAL WASHER, DRYER, STACKED DRYER/ DRYER, COMMERCIAL STACK LAUNDRY, AND MULTI-LOAD COIN OPERATED COMMERCIAL WASHERS AND DRYERS WARRANTY

LIMITED WARRANTY ON PARTS

For the first five years from the date of purchase, when this commercial appliance is installed, maintained and operated according to the instructions attached to or furnished with the product, Maytag brand of Whirlpool Corporation (hereafter "Maytag") will pay for factory specified parts or original equipment manufacturer parts to correct defects in materials or workmanship. Proof of original purchase date is required to obtain service under this warranty.

ITEMS MAYTAG WILL NOT PAY FOR

1. All other costs including labor, transportation, or custom duties.
2. Service calls to correct the installation of your commercial appliance, to instruct you how to use your commercial appliance, to replace or repair fuses, or to correct external wiring or plumbing.
3. Repairs when your commercial appliance is used for other than normal, commercial use.
4. Damage resulting from improper handling of product during delivery, theft, accident, alteration, misuse, abuse, fire, flood, acts of God, improper installation, installation not in accordance with local electrical or plumbing codes, or use of products not approved by Maytag.
5. Pickup and Delivery. This commercial appliance is designed to be repaired on location.
6. Repairs to parts or systems resulting from unauthorized modifications made to the commercial appliance.
7. The removal and reinstallation of your commercial appliance if it is installed in an inaccessible location or is not installed in accordance with published installation instructions.
8. Chemical damage is excluded from all warranty coverage.
9. Changes to the building, room, or location needed in order to make the commercial appliance operate correctly.

DISCLAIMER OF IMPLIED WARRANTIES; LIMITATIONS OF REMEDIES

CUSTOMER'S SOLE AND EXCLUSIVE REMEDY UNDER THIS LIMITED WARRANTY SHALL BE PRODUCT REPAIR AS PROVIDED HEREIN. IMPLIED WARRANTIES, INCLUDING WARRANTIES OF MERCHANTABILITY OR FITNESS FOR A PARTICULAR PURPOSE, ARE LIMITED TO ONE YEAR OR THE SHORTEST PERIOD ALLOWED BY LAW. WHIRLPOOL SHALL NOT BE LIABLE FOR INCIDENTAL OR CONSEQUENTIAL DAMAGES. SOME STATES AND PROVINCES DO NOT ALLOW THE EXCLUSION OR LIMITATION OF INCIDENTAL OR CONSEQUENTIAL DAMAGES, OR LIMITATIONS ON THE DURATION OF IMPLIED WARRANTIES OF MERCHANTABILITY OR FITNESS, SO THESE EXCLUSIONS OR LIMITATIONS MAY NOT APPLY TO YOU. THIS WARRANTY GIVES YOU SPECIFIC LEGAL RIGHTS AND YOU MAY ALSO HAVE OTHER RIGHTS, WHICH VARY FROM STATE TO STATE OR PROVINCE TO PROVINCE.

If you need service, please contact your authorized Maytag Commercial Laundry distributor. To locate your authorized Maytag Commercial Laundry distributor, or for web inquiries, visit www.MaytagCommercialLaundry.com.

9/07

For written correspondence:

Maytag Commercial Laundry Service Department
2000 M-63 North
Benton Harbor, Michigan 49085 USA

GENERAL USER INFORMATION

Blank display

This condition indicates the dryer is inoperative. Check RFI device and for correct voltage to UIC from the transformer.

Scrolling “out of order” message in display

This condition indicates the dryer is inoperative. Diagnostic or Failure Code displayed after the scrolling “out of order” message is the best indication of the reason for the condition.

“0 Minutes” showing in display

This condition indicates the dryer cannot be operated. Coins dropped or debit inputs during this condition will be stored in escrow but cannot be used until normal operation is restored by opening and closing the door. If a door switch fails, it must be replaced before normal operation can be restored.

Cold start (initial first use)

Dryer is programmed at the factory as follows:

- 5 minute dry time for PN models, A series.
- 45 minute dry time for PN models, B series.
- 5 minutes per quarter for PD models.
- \$1.50 dry price (fixed cycle with top off - PD models).
- \$0.00 dry price (fixed cycle - PN models).

Warm Start (after power failure)

A few seconds after power is restored, if a cycle was in progress at the time of the power failure, ‘RESELECT CYCLE’ will flash in the display. This is to indicate the need for a fabric setting button to be pressed to restart dryer.

Pricing

After the door is opened following completion of a cycle, the display indicates the cycle price (unless set for free operation). As coins or debit inputs arrive, the display will change to lead the user through the initiation of a cycle.

There are four (4) types of pricing:

Fixed ‘Vend’ Pricing

A dryer set up for ‘Fixed Cycle’ operation can only accept additional time accumulated by increments equal to the length of a complete dry cycle. A maximum of 99 minutes may be purchased; no additional credit is given when 99 minutes is in the display.

Accumulator Pricing

If the price is set to one coin 1, then accumulator mode is in effect. Cycle time can be purchased one coin at a time (PD models) up to the maximum time of 99 minutes.

Fixed Cycle With Top Off Pricing

A dryer set to offer ‘Top Off’ capability will allow time to be added to an existing dry cycle in increments equal to the number of minutes of dry time per quarter (coin 1), up to 99 minutes, regardless of the cost required to start the dryer. No credit is given for coins or debit inputs entered when the control is displaying 99 minutes.

PN models converted to PR: In Enhanced Debit Mode, the top off price can be set independently. (See VALUE OF COIN 2), and the top off time is calculated according to the following equation:

$$\frac{\text{top off price}}{\text{full cycle price}} = \frac{\text{top off time}}{\text{full cycle length}}$$

Penny increment offset is not applied to top off purchases.

Free Cycles

This is established by setting the cycle price to zero. When this happens 'SELECT CYCLE' will be displayed rather than the cycle price. Any cycle started as a free cycle will automatically terminate when the door is opened.

Debit Card Ready

This dryer is debit card 'cable' ready. It will accept a variety of debit card systems; but, DOES NOT come with a debit card reader, and requires replacement of the fascia. Refer to the debit card reader manufacturer for proper dryer set-up. In models converted with a Generation 1 debit card system, debit pulses represent the equivalent of one coin (coin 1).

CONTROL SET-UP PROCEDURES

IMPORTANT: Read all instructions before operating.

The fabric setting buttons along with the digital display are used to set-up the dryer controls. The display can contain 4 numbers and/or letters and a decimal point. These are used to indicate the set-up codes and related code values available for use in programming the dryer.

How to use the buttons to program the controls

1. WHITES AND COLORS button is used to adjust values associated with set-up codes. Pressing and releasing button will increment value by one (1). Rapid adjustment is possible by holding the button down.
2. The PERM. PRESS button will advance through the set-up codes. Pressing and releasing this button will advance to the next available set-up code. Holding the button down will automatically advance through the set-up codes at a rate faster than one (1) per second.
3. The DELICATES button is used to select or deselect options.

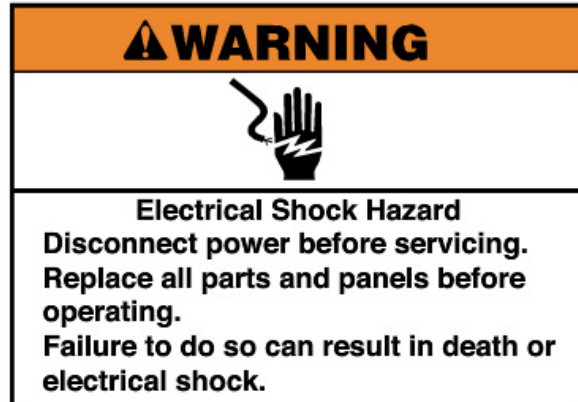

Start Operating Set-Up

- PD models: Insert service access door key, turn, and lift to remove service access door.
- PN models converted to PR: once a Gen 2 card reader is installed (according to the reader manufacturer instructions), the set-up can only be changed by inserting a manual set-up card (supplied by the reader manufacturer) into the card slot. If a manual set-up card is not available, manual set-up mode cannot be entered. However, diagnostic mode can be entered by removing connector AA1 on the User Interface Control (UIC) or by using the Service Access Code. (See page 1-8).

IMPORTANT: The console must not be opened unless power is removed from the dryer. To access connector AA1:

- ✘ Unplug dryer or disconnect power.
- ✘ Open console, disconnect jumper on AA1, close console.
- ✘ Plug in dryer or reconnect power.
- PN Models Equipped with Programming Switch: Insert access panel key and turn counter-clockwise.

The dryer is now in the set-up mode.

Before proceeding, it is worth noting that, despite all the options available, an owner can simply choose to uncrate a new commercial dryer, hook it up, plug it in, and have a dryer that operates.

NOTE: Prior to operation of a PD dryer, a payment system or an OPL kit must be installed.

- PD dryers are pre-set at the factory for fixed cycle price with top off.
- PN dryers are pre-set for free cycle operation so they can be run without readers or coins.

DISPLAY

After the dryer has been installed and plugged in, the display can show '0 minutes.'

All Models



Once the dryer has been plugged in and the dryer door opened and closed, the display will show the vend price. In PN models set for free cycles, the display will flash 'SELECT CYCLE'.

PD Models



PN Models



■ SERVICE ACCESS CODE - PN Models

This code can be entered to access service mode without removing the console. It only functions on dryers set up for 0 vend price without any Special Pricing set-up, and the Coin/Debit Option must be set to "J_d". If the dryer is not in failure mode, the door must be opened to proceed. Service Access Code contains 6 steps and some are timed. Using the three buttons (numbered 1, 2, and 3 from left to right):

1. Press 2 for longer than 2 seconds but less than 10 seconds.
2. Press 1 & 3 together for 2 seconds, then release. Displays S 3.
3. Press 1 & 2 together, then release. Displays S 4.
4. Press 2 & 3 together, then release. Displays S 5.
5. Press 2, then release. Displays "codE".
6. Wait at least 2 seconds, but not more than 15 seconds, then press in succession: 3, 2, 1, 3.

NOTE: If the Service Access Code procedure is not completed properly, as noted above, there is a 15 second delay before it can be attempted again.

There are 3 options to exit from the Service Mode:

1. From Set-up Code 8, press button #1 for 4 seconds.
2. Wait 2 minutes without touching any buttons (without diagnostic modes running).
3. Power down the dryer, then reapply power.

■ **PN Models with a key switch on the console:** Insert access key and turn counter-clockwise.

IMPORTANT: The console must not be opened unless power is removed from the dryer.

To access connector AA1:

1. Unplug dryer or disconnect power.
2. Open console, disconnect plug on AA1, close console.
3. Plug in dryer or reconnect power.

SET-UP CODES

- The PERM. PRESS button will advance from code to code.
- The WHITE AND COLORS button will change the code value.
- The DELICATES button will select or deselect options.

FOR PN MODELS: The set-up codes are the same as for the PD models except where noted.

The set-up code is indicated by the one or two left hand characters. The set-up code value is indicated by the two or three right hand characters. The first value in the code column for each section is the factory default value.

CODE	EXPLANATION
6,06	REGULAR CYCLE PRICE
6,06	Represents the number of coins (coin 1); may adjust from 0–39 (See b.xx set-up for VALUE OF COIN 1). Advance from 0–39 by pressing WHITES AND COLORS. Factory default of 6 x coin 1.
6,00	PN MODELS ONLY: Factory default of 6 00, or 0 coins.
	→ Press PERM. PRESS key pad once to advance to next code.
7,05	REGULAR DRY TIME
7,05	Represents the number of minutes per coin (coin 1). Factory default of 5 minutes per coin. Example: 6 coins x 5 minutes = 30 minutes. By pressing the WHITES AND COLORS key pad, value adjusts from 1–99 minutes.
7,45	PN MODELS: Represents the cycle length for free cycles. As example: '7 45' = 45 minutes.
	→ Press PERM. PRESS key pad once to advance to next code.
8,00	TYPE OF DRYER PRICING
8,00	Fixed Cycle with Top Off. For detailed description, see General User Information.
8,FC	Fixed Cycle. For detailed description, see General User Information. Use DELICATES key pad to make this selection. PN MODELS ONLY: Factory default of FC.
	→ Press PERM. PRESS key pad once to advance to next code.
9,00	CYCLE COUNTER OPTION
	This option is either SELECTED 'ON' or NOT SELECTED 'OFF'.
9,00	Not Selected 'OFF'.
9,0C	Selected 'ON' and not able to be deselected. Press DELICATES key pad 3 consecutive times to select 'ON'. Once selected 'ON' it cannot be deselected.
	→ Press PERM. PRESS key pad once to advance to next code.
1,00	MONEY COUNTER OPTION
	This option is either SELECTED 'ON' or NOT SELECTED 'OFF'.
1,00	Not Selected 'OFF'.
1,0C	Selected 'ON'. Press DELICATES key pad 3 consecutive times to select 'ON' and 3 consecutive times to remove (Not Selected 'OFF'.) Counter resets by going from 'OFF' to 'ON'.
1,CC	Selected 'ON' and not able to be deselected. To select 'ON' and not able to be deselected, first select 'ON', then within two seconds press DELICATES twice, WHITES AND COLORS once, and exit the set-up mode.
	→ Press PERM. PRESS key pad once to advance to next code.

CODE	EXPLANATION																								
<u>2.00</u>	SPECIAL PRICING OPTIONS This option is either SELECTED 'ON' or NOT SELECTED 'OFF'.																								
<u>2.00</u>	Not Selected 'OFF'.																								
<u>2.5P</u>	Selected 'ON'. Press DELICATES key pad once for this selection.																								
If SPECIAL PRICING OPTION is selected, there is access to codes '3.' through '9.'																									
→ Press PERM. PRESS key pad once to advance to next code.																									
OPTIONS TO USE IF SPECIAL PRICING IS SELECTED:																									
<u>3.06</u>	SPECIAL CYCLE PRICE																								
<u>3.06</u>	Represents the number of coins (coin 1); may adjust from 0–39. (See b.xx set-up for VALUE OF COIN 1). Advance from 0–39 by pressing WHITES AND COLORS. Factory default of 6 x coin 1.																								
<u>3.00</u>	PN MODELS: Factory default of 0 coins.																								
→ Press PERM. PRESS key pad once to advance to next code.																									
<u>4.05</u>	SPECIAL DRY TIME																								
<u>4.05</u>	Represents the number of minutes per coin (coin 1). Factory default of 5 minutes per coin. Example: 6 coins x 5 minutes = 30 minutes. By pressing the WHITES AND COLORS key pad, the value can be adjusted from 1–99 minutes.																								
<u>4.45</u>	PN MODELS: Represents the cycle length for free cycles. As example: '4.45' = 45 minutes.																								
→ Press PERM. PRESS key pad once to advance to next code.																									
<u>5.00</u>	TIME-OF-DAY CLOCK, MINUTES																								
<u>5.00</u>	This is the TIME-OF-DAY CLOCK, minute setting; select 0–59 minutes by pressing WHITES AND COLORS key pad.																								
→ Press PERM. PRESS key pad once to advance to next code.																									
<u>6.00</u>	TIME-OF-DAY CLOCK, HOURS NOTE: Uses the 24 hr. clock.																								
<u>6.00</u>	This is the TIME-OF-DAY CLOCK, hour setting; select 0–23 hours by pressing WHITES AND COLORS key pad.																								
→ Press PERM. PRESS key pad once to advance to next code.																									
<u>7.00</u>	SPECIAL PRICE START HOUR NOTE: Uses the 24 hr. clock.																								
<u>7.00</u>	This is the start hour; 0–23 hours. Select START HOUR by pressing WHITES AND COLORS key pad.																								
→ Press PERM. PRESS key pad once to advance to next code.																									
<u>8.00</u>	SPECIAL PRICE STOP HOUR NOTE: Uses the 24 hr. clock.																								
<u>8.00</u>	This is the stop hour; 0–23 hours. Select STOP HOUR by pressing WHITES AND COLORS key pad.																								
→ Press PERM. PRESS key pad once to advance to next code.																									
<u>9.10</u>	SPECIAL PRICE DAY																								
<u>9.10</u>	This represents the day of the week and whether special pricing is selected for that day. A number followed by '0' indicates no selection that particular day (9.10). A number followed by an 'S' indicates selected for that day (9.1S). Day of week (1-7) can be chosen by pressing the WHITES AND COLORS key pad. Press DELICATES key pad once to select special pricing for each day chosen. When exiting setup code '9.', the display must show current day of week:																								
	<table border="1"> <thead> <tr> <th>DISPLAY</th> <th>DAY OF WEEK</th> <th>CODE (selected)</th> </tr> </thead> <tbody> <tr> <td>10</td> <td>Day 1 = Sunday</td> <td>1S</td> </tr> <tr> <td>20</td> <td>Day 2 = Monday</td> <td>2S</td> </tr> <tr> <td>30</td> <td>Day 3 = Tuesday</td> <td>3S</td> </tr> <tr> <td>40</td> <td>Day 4 = Wednesday</td> <td>4S</td> </tr> <tr> <td>50</td> <td>Day 5 = Thursday</td> <td>5S</td> </tr> <tr> <td>60</td> <td>Day 6 = Friday</td> <td>6S</td> </tr> <tr> <td>70</td> <td>Day 7 = Saturday</td> <td>7S</td> </tr> </tbody> </table>	DISPLAY	DAY OF WEEK	CODE (selected)	10	Day 1 = Sunday	1S	20	Day 2 = Monday	2S	30	Day 3 = Tuesday	3S	40	Day 4 = Wednesday	4S	50	Day 5 = Thursday	5S	60	Day 6 = Friday	6S	70	Day 7 = Saturday	7S
DISPLAY	DAY OF WEEK	CODE (selected)																							
10	Day 1 = Sunday	1S																							
20	Day 2 = Monday	2S																							
30	Day 3 = Tuesday	3S																							
40	Day 4 = Wednesday	4S																							
50	Day 5 = Thursday	5S																							
60	Day 6 = Friday	6S																							
70	Day 7 = Saturday	7S																							
→ Press PERM. PRESS key pad once to advance to next code.																									

CODE	EXPLANATION
<u>A.00</u>	VAULT VIEWING OPTION This option is either SELECTED 'ON' or NOT SELECTED 'OFF'.
<u>A.00</u>	Not Selected 'OFF'.
<u>A.5C</u>	Selected 'ON'. Press DELICATES key pad once for this selection. When selected, the money and/or cycle counts will be viewable (if counting is selected) when the coin box is removed.
→ Press PERM. PRESS key pad once to advance to next code.	
<u>b.05</u>	VALUE OF COIN 1
<u>b.05</u>	This represents the value of coin 1 in the quantity of 5% increments of the larger coin value. 5 x 5% = 25%. By pressing the WHITES AND COLORS key pad, there is the option of 1–199 for the quantity of 5% increments. With coin slide activation, this represents the total vend price.
→ Press PERM. PRESS key pad once to advance to next code.	
<u>C.20</u>	VALUE OF COIN 2
<u>C.20</u>	This represents the value of coin 2 in the quantity of 5% increments of the larger coin value. 20 x 5% = 100%.
<u>C.05</u>	By pressing the WHITES AND COLORS key pad, there is the option of 1–199 for the quantity of 5% increments. PN MODELS: This represents the value of coin 2 in the quantity of 5% increments of the larger coin value. Factory default = 5 x 5% of the larger coin value. PN MODELS USING ENHANCED DEBIT: This represents the value of top off in quantity of 5% increments of the larger coin value. Factory default = 5 x 5% of the larger coin value.
→ Press PERM. PRESS key pad once to advance to next code.	
<u>d.00</u>	COIN SLIDE OPTION This option is either SELECTED 'ON' or NOT SELECTED 'OFF'. Replacement of meter case will be needed for coin slide mounting.
<u>d.00</u>	Not Selected 'OFF'.
<u>d.5</u>	NOTE: This option needs to be set to '00' unless the meter case has been changed to accept a coin slide device. Selected 'ON'. Press DELICATES key pad 3 consecutive times for this selection. When coin slide mode is selected, set 'b.' equal to value of slide in coins. Set '6 xx' (REGULAR CYCLE PRICE) and '3.xx' (SPECIAL CYCLE PRICE) to number of slide operations. 6 01 & 3.01 = 1 slide push. NOTE: If the installer sets up 'CS' on a coin drop model, it will not register coins.
→ Press PERM. PRESS key pad once to advance to next code.	
<u>E.00</u>	ADD COINS OPTION This option is either SELECTED 'ON' or NOT SELECTED 'OFF'. This option causes the customer display to show the number of coins (coin 1) to enter, rather than the amount.
<u>E.00</u>	Not Selected 'OFF'.
<u>E.RC</u>	Selected 'ON'. Press DELICATES key pad 3 consecutive times for this selection. PN MODELS ONLY: In enhanced debit mode, this option is not selectable.
→ Press PERM. PRESS key pad once to advance to next code.	

CODE	EXPLANATION
COIN/DEBIT OPTION	
J_d	Both coin & debit selected. (NOT AVAILABLE)
J_d	Coins selected, debit disabled. Press DELICATES key pad for this selection.
J_d	Debit Card selected, coin disabled. Default for PN models, and for PN operation, must be set as J_d. Press DELICATES key pad for this selection.
JEd	Enhanced debit is self-selected when a Generation 2 card reader is installed in the dryer. The 'Ed' option cannot be manually selected or deselected. (NOT AVAILABLE)
→ Press PERM. PRESS key pad once to advance to next code.	
PRICE SUPPRESSION OPTION	
L_00	This option is either SELECTED 'ON' OR NOT SELECTED 'OFF'. This option causes the customer display to show 'AVAILABLE' or 'ADD' rather than the amount of money to add. (Used mainly in debit installations.)
L_00	Not Selected 'OFF'.
L_PS	Selected 'ON'. Press DELICATES key pad once for this selection.
→ Press PERM. PRESS key pad once to advance to next code.	
CLEAR ESCROW OPTION	
n_EE	This option is either SELECTED 'ON' OR NOT SELECTED 'OFF'. When selected, money held in escrow for 30 minutes without further escrow or cycle activity will be cleared.
n_EE	Selected 'ON'.
n_00	Not Selected 'OFF'. Press DELICATES key pad once to deselect this option.
→ Press PERM. PRESS key pad once to advance to next code.	
HUNDRETH INCREMENT OFFSET	
U_00	This represents the hundredth increment price offset used in Generation 2 (Enhanced Debit) PN models. Choose from 0-4 hundredths by pressing the WHITES AND COLORS key pad. (NOT AVAILABLE)
→ Press PERM. PRESS key pad once to advance to next code.	

If cycle counter (9 0C) is selected, the following is true:

1 00 Cycles in Hundreds	1 02 = 200
2 00 Cycles in Ones	2 25 = 25
TOTAL CYCLES = 225	

This is "VIEW ONLY" and cannot be cleared. Press the PERM. PRESS button once to advance to next code.

If money counter (1.0C or 1.C0) is selected, the following is true:

3 00 Currency in Hundreds	3 01 = 100.00
4 00 Currency in Ones	4 68 = 68.00
5 00 Currency in Hundredths	5 75 = 0.75
TOTAL = 168.75	

END OF SET-UP PROCEDURES

EXIT FROM SET-UP MODE

- PD MODELS: Reinstall service access door
- PN MODELS CONVERTED TO PR: Remove set-up card
- PN MODELS where AA1 connector was removed:
 1. Unplug dryer or disconnect power.
 2. Open console, reinsert jumper into AA1, close console.
 3. Plug in dryer or reconnect power.
- PN MODELS WHERE SERVICE ACCESS CODE WAS USED: From Set-up Code 8, press button #1 for 4 seconds. Wait 2 minutes without touching any buttons (without diagnostic modes running), or power down the dryer, then reapply power.
- PN MODELS WHERE KEY SWITCH IS INSTALLED: Turn key clockwise and remove key.

MAYTAG COMMERCIAL LAUNDRY LITERATURE LIST HIGH EFFICIENCY PRODUCT

PRODUCT TYPE	MODEL	Install Instruct	Tech Sheet	Service Parts List
Electric Dryer	MDE22PDAYW0	W10135154	W10239200	W10135169
	MDE22PDBZW0	W10277179	W10239202	W10273436
	MDE22PRBZW0	W10277179	W10239202	W10273434
	MDE22PNAGW0	W10239198	W10239197	W10239193
	MDE22PDBYW0	W10277179	W10239202	W10273438
	MDE22PRBYW0	W10277179	W10239202	W10273432
	MDE22PDAGW0	W10135154	W10239197	W10239192
	MDE22PDAZW0	W10135154	W10239200	W10135171
	MDE22PRAZW0	W10135154	W10239200	W10135174
	MDE22PRAYW0	W10135154	W10239200	W10135173
	MDE25PDAZW0	W10239206C	W10353871A	W10335186
	MDE25PRAZW0	W10239206C	W10353871A	W10335196
	MDE25PRAYW0	W10239206C	W10353871A	W10335195
	MDE25PDAYW0	W10239206C	W10353871A	W10335184
	MDG25PDAWW0	W10239206C	W10353871A	W10335188
	MDE25PNAGW0	W10279206	W10166379A	W10335197
	MDE25PDAGW0	W10239206	W10166379A	W10335187
	MDE28PNAGW0	W10279206	W10166379A	W10335197
	MDE28PDAGW0	W10239206	W10166379A	W10335187
Gas Dryer	MDG22PDBWW0	W10277179	W10239202	W10273437
	MDG22PDAWW0	W10135154	W10239200	W10135170
	MDG22PDAGW0	W10239199	W10239197	W10239194
	MDG22PDAXW0	W10135154	W10239200	W10135172
	MDG22PRAWW0	W10135154	W10239200	W10135175
	MDG22PRBWW0	W10277179	W10239202	W10273433
	MDG22PNAGW0	W10239199	W10239197	W10239195
	MDG22PDBXW0	W10277179	W10239202	W10273435
	MDG25PRAWW0	W10239206C	W10353871A	W10335198
	MDG25PDAWW0	W10239206C	W10353871A	W10335189
	MDG25PNAGW0	W10239207	W10166379A	W10235199
	MDG25PDAGW0	W10239207	W10166379A	W10335191
	MDG28PNAGW0	W10239207	W10166379A	W10235199
	MDG28PDAGW0	W10239207	W10166379A	W10335191

INSTALLATION INFORMATION

TOOLS AND PARTS

Gather the required tools and parts before starting installation. Read and follow the instructions provided with any tools listed here.

Tools needed:

- 8" or 10" Pipe wrench
- 8" or 10" adjustable wrench that opens to 1" (2.5 cm)
- Flat-blade screwdriver
- Star head screwdriver
- T-20 Security screwdriver or bit
- Level
- 1/4" & 5/16" sockets with wrench
- Utility knife
- Pipe-joint compound resistant to type of gas used.
- Caulking gun and caulk (for installing new exhaust vent)
- Pliers

Parts supplied:

Remove parts bag from dryer drum. Check that all parts were included.

- Foot boot (4)
- Dryer foot (4)
- Coin sensor (2) PD only
- International power cord connectors (Gas only)

LOCATION REQUIREMENTS

⚠ WARNING

<p>Explosion Hazard</p> <p>Keep flammable materials and vapors, such as gasoline, away from dryer.</p> <p>Do not install in a garage.</p> <p>Failure to do so can result in death, explosion, or fire.</p>

If installing a gas dryer:

IMPORTANT: Observe all governing codes and ordinances.

- Check code requirements: Some codes limit or do not permit installation of clothes dryers in garages, closets, or sleeping quarters. Contact the local building inspector.
- Make sure that lower edges of the cabinet, plus the back and bottom sides of the dryer, are free of obstructions to permit adequate clearance of air openings for combustion air. See “Recessed Area and Closet Installation Instructions” below for minimum spacing requirements.

NOTE: The dryer must not be installed in an area where it will be exposed to water and/or weather.

Recessed Area and Closet Installation Instructions:

Commercial dryers may be installed in a recessed area or closet. For recessed area and closet installations, minimum clearances can be found in the Installation Instructions.

The installation spacing is in inches and is the minimum allowable. Additional spacing should be considered for ease of installation, servicing, and compliance with local codes and ordinances.

If closet door is installed, the minimum unobstructed air opening in the top and bottom is required. Louvered doors with equivalent air openings are acceptable.

The dryer must be exhausted outdoors. No other fuel-burning appliance may be installed in the same closet as the dryer.

VENTING REQUIREMENTS

⚠ WARNING

<p>Fire Hazard</p> <p>Use a heavy metal vent.</p> <p>Do not use plastic vent.</p> <p>Do not use metal foil vent.</p> <p>Failure to follow these instructions can result in death or fire.</p>

WARNING: To reduce the risk of fire, this dryer **MUST BE EXHAUSTED OUTDOORS.**

- The dryer vent must not be connected into any gas vent, chimney, wall, ceiling, or a concealed space of a building.
- Make sure not to use an exhaust hood with a magnetic latch.
- Make sure not to install flexible metal vent in enclosed walls, ceilings or floors.
- 4" (10.2 cm) diameter rigid metal vent and clamps must be used.
- Use clamps to seal all joints. Vent must not be connected or secured with screws or other fastening devices which extend into the interior of the vent. Make sure not to use duct tape.

IMPORTANT: Observe all governing codes and ordinances.

Use a heavy metal vent. Make sure not to use plastic or metal foil vent.

Rigid metal vent is recommended to avoid crushing and kinking.

Flexible metal vent must be fully extended and supported when the dryer is in its final position. Remove excess flexible metal vent to avoid sagging and kinking that will result in reduced airflow and poor performance.

An exhaust hood should cap the vent to avoid rodents and insects from entering the home or business.

Exhaust hood must be at least 12" (30.5 cm) from the ground or any object that may be in the path of the exhaust (such as flowers, rocks or bushes).

If using an existing vent system, clean lint from the entire length of the system and make sure exhaust hood is not plugged with lint. Replace any plastic or metal foil vent with rigid metal or flexible metal vent.

Plan installation to use the fewest number of elbows and turns.

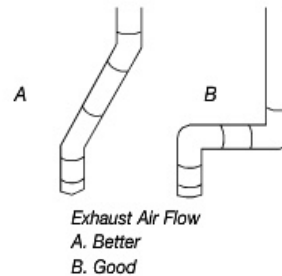

Allow as much room as possible when using elbows or making turns. Bend vent gradually to avoid kinking.

Vent outlets are located at the bottom of the dryer in the rear, on the bottom panel and on the right and left side panels. Vents can be routed up, down, left, right, behind the dryer or straight out the back of the dryer.

Vent System Length

Maximum length of vent system depends upon the type of vent used, number of elbows and type of exhaust hood. The maximum length for both rigid and flexible vent is shown in the chart.



Rigid Metal Vent		
No. of 90° turns	Box Hood and Louvered Style	Angled Hood Style
0	135 ft. (41.2 m)	129 ft. (39.3 m)
1	125 ft. (38.1 m)	119 ft. (36.3 m)
2	115 ft. (35.1 m)	109 ft. (33.2 m)
3	106 ft. (32.3 m)	100 ft. (30.5 m)
4	98 ft. (29.9 m)	92 ft. (28.0 m)

Flexible Metal Vent		
No. of 90° turns	Box Hood and Louvered Style	Angled Hood Style
0	76 ft. (23.2 m)	62 ft. (18.9 m)
1	71 ft. (21.6 m)	57 ft. (17.4 m)
2	67 ft. (20.4 m)	53 ft. (16.2 m)
3	65 ft. (19.8 m)	51 ft. (15.6 m)
4	63 ft. (19.2 m)	49 ft. (14.9 m)

If dryer is installed in a confined area, such as a bedroom, bathroom or closet, provision must be made for enough air for combustion and ventilation. (Check governing codes and ordinances.) See “Recessed Area and Closet Installation Instructions” in the “Location Requirements” section of the installation instructions.

4” (10.2 cm) outlet hoods are preferred. This is a hood that measures 4” from the wall to the bottom outside edge of the hood. However, 2 1/2” angled (6.4 cm) outlet exhaust hoods may be used. 2 1/2” angled (6.4 cm) outlet hoods create greater back pressure than other hood types.

For permanent installation, a stationary vent system is required. 4” rigid vent pipe is always the preferred ventilation piping for single-load dryer installations.

Static pressure measured at each dryer must not exceed 1” or be less than .06” water column.

Multiple Dryer Venting

- A main vent can be used for venting a group of dryers. Main vent should be sized to remove 200 CFM of air per dryer. Large-capacity lint screens of proper design may be used in the main vent if checked and cleaned frequently. The room where the dryers are located should have make-up air equal to or greater than the CFM of all the dryers in the room, see below.

Unobstructed air openings are required for make up combustion air. A static opening of 24 square inches (1 Inch² per 1,000 BTU of burner) is the minimum required for each dryer in operation. A common opening may be used if the return air is distributed equally to all dryers in operation.

- Back-draft dampers are available and should be installed in each dryer vent to avoid exhausted air from returning into the dryers and to keep the exhaust in balance within the main vent.

Each vent should enter the main vent at an angle pointing in the direction of the airflow. Vents entering from the opposite side should be staggered to reduce the exhausted air from interfering with the other vents.

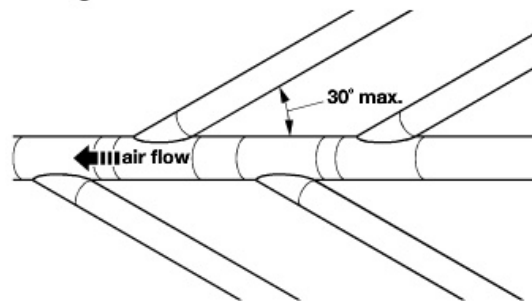

The maximum angle of each vent entering the main vent should be no more than 30°. Keep air openings free of dry cleaning fluid fumes. Fumes create acids which, when drawn through the dryer heating elements, can damage dryers and loads being dried.

A clean-out cover should be located on the main vent for periodic cleaning of the vent system.

If an exhaust hood cannot be used:

The outside end of the main vent should have a sweep elbow directed downward. If the main vent travels vertically through the roof, rather than through the wall, install a 180° sweep elbow on the end of the vent at least 2 ft. (61 cm) above the highest part of the building. The opening, wall or roof, shall have a diameter 1/2" (1.3 cm) larger than the vent diameter.

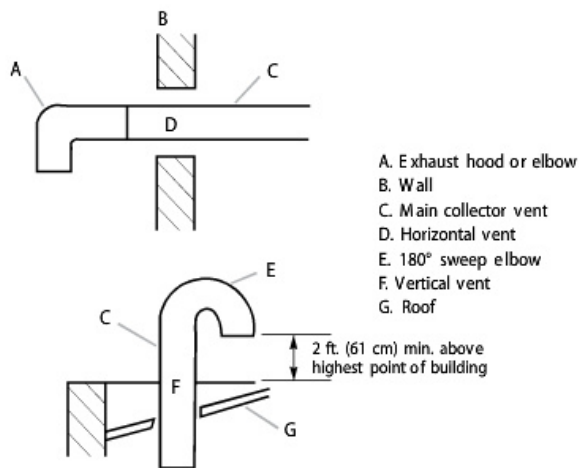

The vent should be centered in the opening.
 Make sure not to install screening or cap over the end of the vent.

GAS PIPE CHART (NATURAL GAS)

The chart shows the maximum capacity in terms of cubic feet of gas per hour, for various sizes of pipe at lengths of from 10 feet to 200 feet. The column on the left is the nominal iron pipe size shown in Inches. Sizes range from 1/4" to 4". The next column shows the internal diameter of the pipe in decimal inches.

The numbers across the top of the chart are lengths of pipe from 10 feet up to 200 feet. The numbers in the body of the chart are maximum capacities of cubic feet of GAs per hour.

To determine the cubic feet of gas required per hour, divide the total BTU input of all the dryers which will be on the line by the average BTU heating value per cubic foot of the gas used.

EXAMPLE:

The dryer has a rating of 30,000 BTU. If the average BTU rating of natural gas is 1000, divide 30,000 by 1000 and get 30. If for example, eight dryers are to be operated on a gas line, the following figures would be used:

$$\begin{array}{r}
 30 \text{ Cubic feet per hour each} \\
 \times 8 \text{ Dryers} \\
 \hline
 240 \text{ Total cubic feet of gas per hour}
 \end{array}$$

Let's assume 40 feet of pipe is required. This is how to use the chart:

1. Look across the top of the chart and find 40 feet of pipe.
2. Look down into the body of the chart to get to, or just over the maximum needed cubic feet of gas per hour. In this case it will be 245.
3. Look to the left column and see a 1" pipe is required.

Nominal iron pipe size, inches	Internal diameter inches	Length of pipe, feet													
		10	20	30	40	50	60	70	80	90	100	125	150	175	200
1/4	.364	32	22	18	15	14	12	11	11	10	9	8	8	7	6
3/8	.493	72	49	40	34	30	27	25	23	22	21	18	17	15	14
1/2	.622	132	92	73	63	56	50	46	43	40	38	34	31	28	26
3/4	.842	278	190	152	130	115	105	96	90	84	79	72	64	59	55
1	1.048	520	350	285	245	215	195	160	170	160	150	130	120	110	100
1 1/4	1.380	1050	730	590	500	440	400	370	350	320	305	275	250	225	210
1 1/2	1.610	1600	1100	890	760	670	610	560	530	490	400	410	380	350	320
2	2.087	3050	2100	1650	1450	1270	1150	1050	990	930	870	780	710	650	610
2 1/2	2.169	4860	3300	2700	2300	2000	1850	1700	1600	1500	1400	1250	1130	1050	980
3	3.068	8500	5900	4700	4100	3600	3250	3000	2800	2600	2500	2200	2000	1850	1700
4	4.026	17,500	12,000	9700	8300	7400	6800	6200	5800	5400	5100	4500	4100	3800	3500

THEORY OF OPERATION

STARTING THE DRYER

⚠ WARNING

<p style="text-align: center;">Explosion Hazard</p> <p>Keep flammable materials and vapors, such as gasoline, away from dryer.</p> <p>Do not dry anything that has ever had anything flammable on it (even after washing).</p> <p>Failure to follow these instructions can result in death, explosion, or fire.</p>

⚠ WARNING

<p style="text-align: center;">Fire Hazard</p> <p>No washer can completely remove oil.</p> <p>Do not dry anything that has ever had any type of oil on it (including cooking oils).</p> <p>Do not dry items containing foam, rubber, or plastic in this dryer.</p> <p>Doing so can result in death or fire.</p>

Commercial dryers may or may not require a payment system to operate. If required, once payment is established, following the instructions on the console leads the user through the procedure for selecting a cycle to care for their particular fabrics. After the dryer has started, the display will show the selected cycle as well as the countdown of the time left in the cycle.

Any cycle started as a free cycle will end with the opening of the door any time during that cycle.

AIR INTAKE AND EXHAUST

Room temperature air (white arrows) enters the lower portion of the dryer through a gap formed behind the bottom of the lower front panel. Therefore it is very important to raise the bottom of the dryer by installing the feet properly. This room air is drawn through the heating system (gas burner or electric element).

Heated dry air (dark arrows) is then drawn up the heat duct mounted behind the rear bulkhead and then into the drum.

As the dry heated air circulates in the drum it picks up moisture from the wet clothes. The more space around tumbling clothes for dry heated air to come into contact with fabric, the faster clothes will dry.

The moistened heated air is drawn down through the lint filter, through the blower and into the exhaust duct, where it is vented out of the dryer and out of the building.

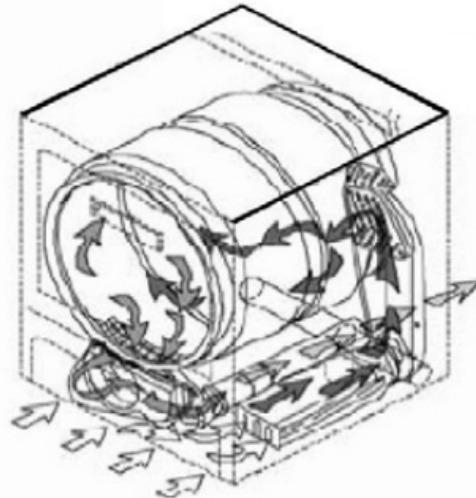

Capacity	190 Liters	One washer load is a full dryer load
Motor	Thermo-protected against overload auto-reset	1/3 HP, 240 Volt, 50 Hz
Air Flow	Cubic feet per minute exhausted from dryer	6.1m ³ /m ³ Electric 6.5 m ³ /m ³ Gas
Tumbler	Revolution per minute	50 RPM ± 1.5
Rotation	Drum Turning, when viewed from the front	Clockwise
Heat Source	<ul style="list-style-type: none"> • Electric • Gas 	<ul style="list-style-type: none"> • USA 240v, 4600 watts, 30 amp fuse • Single port burner 20,000 BTU/hr. direct ignition, automatic shut-off
Exhaust	Venting size	10.2 cm (4") rigid duct (See installation instructions provided with the dryer for additional information)
Makeup Air	Free opening	Requires 193 sq cm per dryer pocket
Static Pressure	Single unit exhaust, 10.2 cm(4") round rigid duct.	Should not exceed 0.92" or be less than 0" water column.

TYPICAL CYCLE OF OPERATION

When WHITES AND COLORS is selected, the high heat cycle is activated. The high temp cycle uses the circuit that involves the 68.3°C (155°F) setting for the exhaust thermistor.

After the cycle type is selected on all models, the dryer motor circuit is energized. The motor has power sent to both the Run and the Start windings because the motor switch contacts 5 to 3 is closed. When the motor reaches run speed the centrifugal switch snaps closed and the motor switches change position. Motor contact 5 continues to power the main motor winding, but contact 3 becomes an open circuit (infinite Ω) to the start winding.

At the same time motor contact 1 closes to 2, which allows the completing of the heater circuit. Now the blower, the drum, and the heat are all working.

Notice the components in this gas heat circuit; heat can be shut off by opening any of the in-line components:

1. Thermal Fuse
2. Exhaust Thermistor
3. High temp cutout
4. High temp thermostat
5. Motor Switch 1M to 2M
6. Gas Valve Coils

Not so obvious is the door switch when open will open the motor relay in the CCU and that opens contacts 1 to 2 of the motor switch.

Using this same theory we can show that if there is line voltage showing at the 2-pin connector for the gas valve, then all of the thermal components are closed and OK! We would also know that the motor switch 1M to 2M is closed as well, because one side of the line voltage must pass through this motor switch that is only closed when the motor is running.

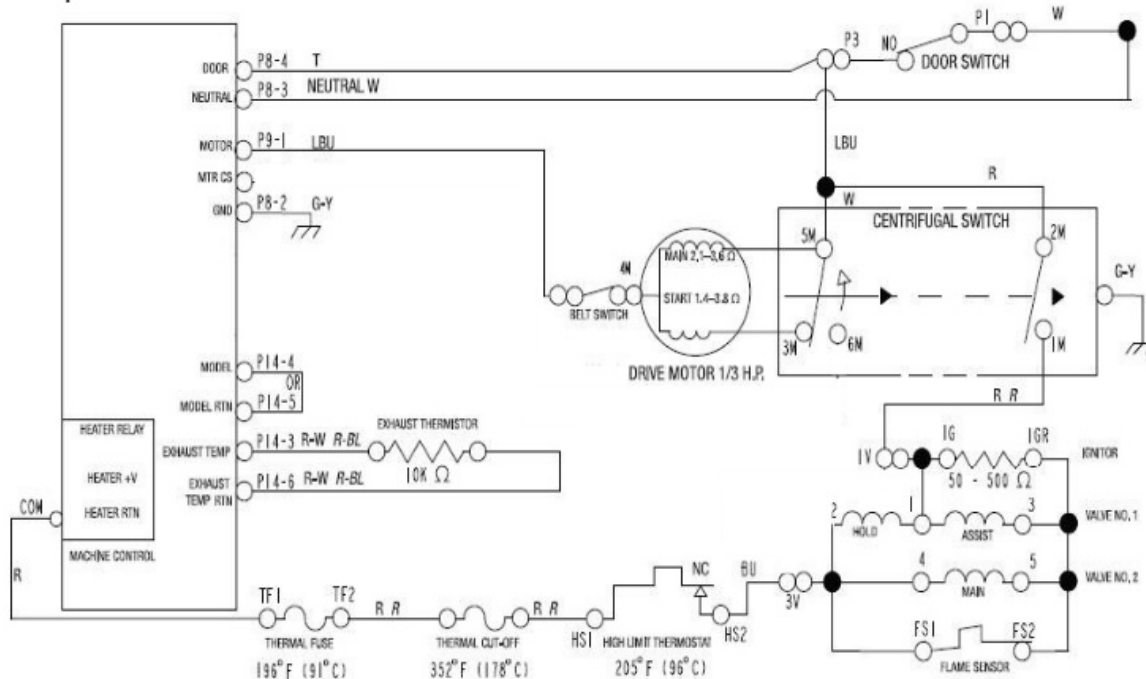

The broken belt switch is in series with the motor and has one of its leads connect directly to a terminal on the motor thermal overload. If either the broken belt switch or the motor thermal overload opens the circuit, it will stop the motor, which in turn will cause the motor centrifugal switch to open and change the position of the motor switches, opening motor switch 1M to 2M, which opens the circuit to either the electric element or the gas coil circuit from a leg of the power supply.

Door switches on this dryer are wired in series with each other, but are not wired in series with any other components. When a door switch is opened or closed it is the Central Control Unit (CCU) that senses this and activates or deactivates the relays on the board. Whenever the door switch state is sensed as closed in the CCU it allows the Select Cycle or Reselect Cycle to display on PD or PN models converted to PR after correct vend price is applied. On PN models set-up for free vend the display would show Select Cycle after the door switch state is changed and then detected as closed.

With all pay for use commercial dryers, whenever the power is supplied to the dryer and the cycle has been started, time continues to count down even if the cycle is interrupted by the opening of the door switch.

Dryers set as On Premises Laundry (OPL), set for free vend; when a cycle is interrupted with a door opening or power failure, that cycle will be cancelled, and a new full cycle will need to be started if additional dry time is required.

UNDERSTANDING THE GAS VALVE AND IGNITION SYSTEM

The sensor, ignitor and gas valve are interrelated and function as the ignition and heat source for gas dryers. At the start of the cycle the radiant sensor contacts are closed, the ignitor is at room temperature and the gas valve is closed, blocking the flow of gas. In the wiring diagram below, the radiant sensor contacts are wired in parallel with the gas valve secondary coil. This bypasses current around the secondary coil when the radiant sensor contacts are closed. Therefore valve #2 cannot open as long as the radiant sensor contacts are closed.

The booster coil and the ignitor are wired in parallel, although they are still wired in series with both the radiant sensor and secondary coil combination.

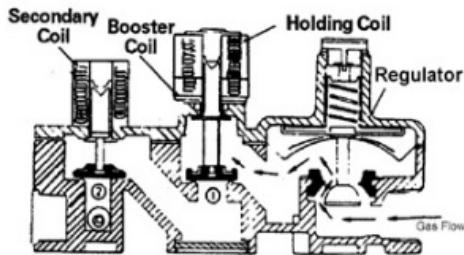
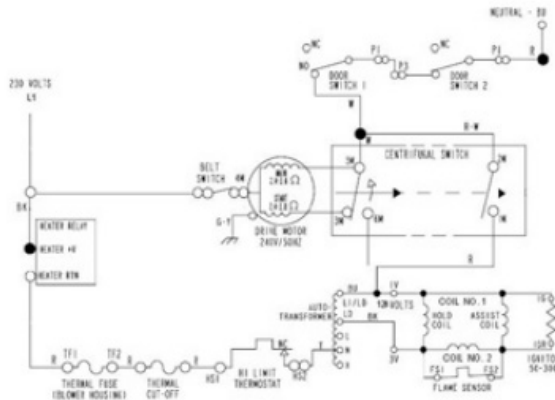

When the radiant sensor contacts are closed, full line voltage is available to the booster coil and to the ignitor. When the radiant sensor contacts open, the current has to flow through the secondary coil on gas valve #2 in order to get to the booster coil and the ignitor.

A significant voltage drop develops across the secondary coil, which renders both the booster coil and the ignitor ineffective due to their high resistance and the reduced voltage available, even though they are still in the circuit.

Radiant Sensor Contacts Closed

The holding coil, the booster coil, and the ignitor all receive line voltage. The holding coil and booster coil open gas valve #1. Gas valve #2 is still closed, prohibiting gas to flow to the burner. The ignitor, operating at line voltage, begins to get very hot. (As the ignitor gets hotter the resistance of the ignitor drops) The ignitor glow radiates heat to the radiant sensor and as long as the radiant sensor contacts are closed the secondary coil of the gas valve #2 are bypassed.

Radiant Sensor Contact Open

The ignitor is now very hot and valve #1 is open. The radiant heat from the ignitor causes the contacts in the radiant sensor to open. With the radiant sensor contacts open the secondary coil of the gas valve is no longer bypassed. The secondary coil is now in series with the parallel circuit combination of booster coil and ignitor.

Because of the relatively low resistance of the hot glowing ignitor, most of line voltage is dropped across the secondary coil. The remaining voltage is dropped across the booster coil and ignitor. The secondary coil now opens gas valve #2 allowing the gas to flow through both valve #1 and valve #2 to the burner where it comes in contact with the still very hot ignitor and the gas flow is ignited.

NOTE: Since the ignitor will begin to cool, the tip of the ignitor is left in the flame to keep the resistance low enough to keep the secondary coil powered, which keeps the gas flowing and the flame burning.

⚠ WARNING

Explosion Hazard
<p>Keep flammable materials and vapors, such as gasoline, away from dryer.</p> <p>Do not dry anything that has ever had anything flammable on it (even after washing).</p> <p>Failure to follow these instructions can result in death, explosion, or fire.</p>

CLEANING THE DRYER LOCATION

Keep Dryer area clear and free from items that would obstruct the flow of combustion and ventilation air.

CLEANING THE LINT SCREEN

Every load cleaning:

The lint screen is located in the door opening of the dryer. A screen blocked by lint can increase drying time.

To clean:

1. Pull the lint screen straight up. Roll lint off the screen with your fingers. Do not rinse or wash screen to remove lint because wet lint is hard to remove.

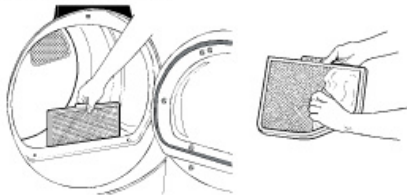

2. Push the lint screen firmly back into place.

IMPORTANT:

- Do not run the dryer with the lint screen loose, damaged, blocked, or missing. Doing so can cause overheating and damage to both the dryer and fabrics.
- If lint falls off the screen into the dryer during removal, check the exhaust hood and remove the lint.

As needed cleaning:

Laundry detergent and fabric softener residue can build up on the lint screen. This buildup can cause longer drying times for the clothes, or cause the dryer to stop before the load is completely dry.

Clean the lint screen with a nylon brush every 6 months, or more frequently, if it becomes clogged due to a residue buildup.

To Wash:

1. Roll lint off the screen with your fingers.
2. Wet both sides of lint screen with hot water.
3. Wet a nylon brush with hot water and liquid detergent. Scrub lint screen with the brush to remove residue buildup.



4. Rinse screen with hot water.
5. Thoroughly dry lint screen with a towel. Reinstall screen into dryer.

CLEANING THE DRYER INTERIOR

To clean dryer drum:

1. Make a paste with powdered laundry detergent and very warm water.
2. Apply paste to a soft cloth, or, apply a liquid non flammable household cleaner to the stained area and rub with a soft cloth until all excess dye and stains are removed.
3. Wipe drum thoroughly with a damp cloth.
4. Tumble a load of clean cloths or towels to dry drum.

NOTE: Garments which contain unstable dyes, such as denim blue jeans or brightly colored cotton items, may discolor the dryer interior. These stains are not harmful to the dryer and will not stain future loads of clothes. Dry unstable dye items inside out to avoid dye transfer.

REMOVING ACCUMULATED LINT

From Inside the dryer cabinet:

Lint should be removed every year, or more often, depending on dryer usage. Cleaning should be done by a qualified person.

From the exhaust vent:

Lint should be removed every 2 years, or more often, depending on dryer usage.

VACATION AND MOVING CARE

Vacation Care:

Operate the dryer only when people are present. If going on vacation or not using the dryer for an extended period of time:

1. Unplug dryer or disconnect power.
2. Close shutoff valve in gas supply line.
3. Clean lint screen (See page 3-6).

Moving care:

For power supply cord-connected dryers:

1. Unplug dryer and disconnect exhaust vent.
2. Close shutoff valve in gas supply line.
3. Disconnect gas supply line pipe and remove fittings attached to dryer pipe.
4. Cap the open fuel supply line.
5. Make sure leveling legs are secure in dryer base.
6. Use masking tape to secure dryer door.

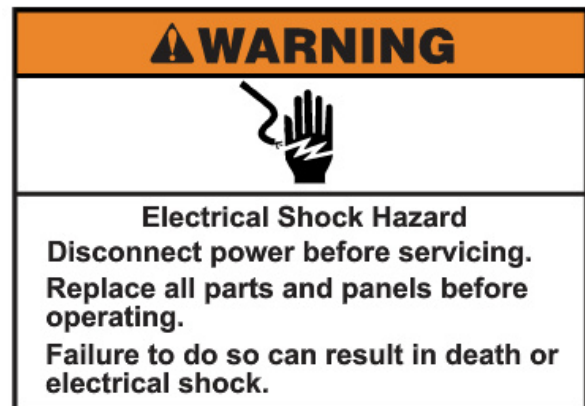

For direct-wired dryers:

1. Disconnect power.
2. Disconnect wiring.
3. Make sure leveling legs are secure in dryer base.
4. Use masking tape to secure dryer door.

DRYER GAS SPECS

Factory set for NATURAL GAS: Injector size: 2.2 mm Heat input gross: 5.9 kW		
European Country:	CH, CZ, CY, ES, GB, GR, HR, IE, IT, PT, SI, SK, TR	AT, CH, CY, CZ, DK, EE, FI, GR, HU, IT, NO, RO, SE, SK, TR
European Gas Category:	II ₂ H ₃ +	II ₂ H ₃ B/P
Gas Flow Rate:	0.562703 m ³ /hr	0.562703 m ³ /hr
Supply Pressure (G20):	20 mbar	20 mbar
Factory Adjusted Pressure:	7.4 mbar	7.4 mbar
With LP Gas Conversion Kit: Injector size: 1.25 mm Heat input gross: 6.4 kW		
European Country:	CH, CZ, CY, ES, GB, GR, HR, IE, IT, PT, SI, SK, TR	AT, CH, CY, CZ, DK, EE, FI, GR, HU, IT, NO, RO, SE, SK, TR
European Gas Category:	II ₂ H ₃ +	II ₂ H ₃ B/P
Butane Supply Pressure (G30):	28-30 mbar	30 mbar
Adjusted Pressure:	N/A	N/A
Propane Supply Pressure (G31):	37 mbar	30 mbar
Adjusted Pressure:	N/A	N/A
With France/Belgium NATURAL GAS conversion kit: Injector size: 1.65 mm Heat input gross: 5.9 kW		
European Country:	FR, BE	
European Gas Category:	I ₂ E+	
Supply Pressure (G20):	20 mbar	
Supply Pressure (G25):	25 mbar	
Adjusted Pressure:	N/A	
<p>NOTE: Conversion kit : From Natural Gas to LP Gas : Whirlpool Part No. W10233219. Conversion kit : From Natural Gas to Natural Gas - France/Belgium: Whirlpool Part No. W10184947. Manufacturer : Whirlpool Corporation, Benton Harbor, Michigan 49022, USA.</p>		

🔧 COMPONENT ACCESS

COMPONENT LOCATIONS FOUND BEHIND THE FRONT PANEL

The components and their locations are shown below.

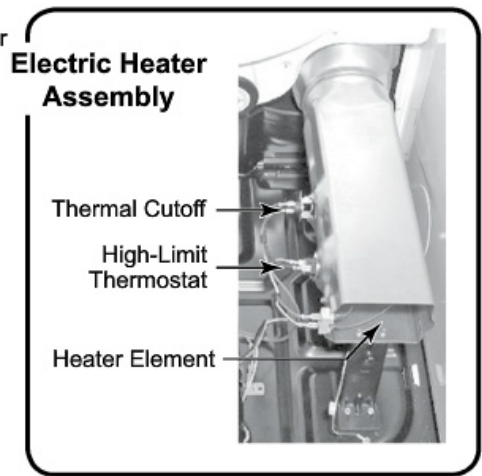
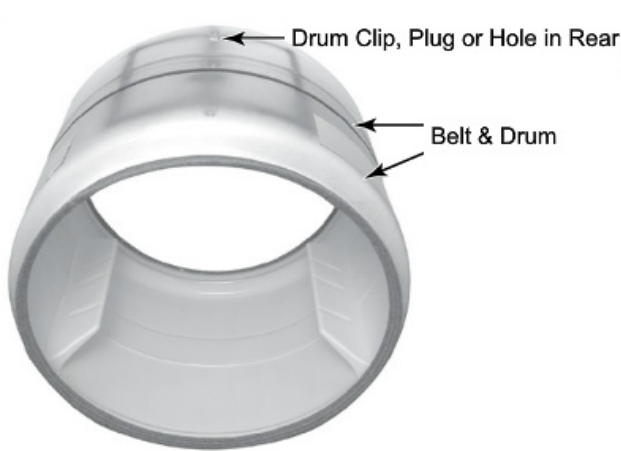
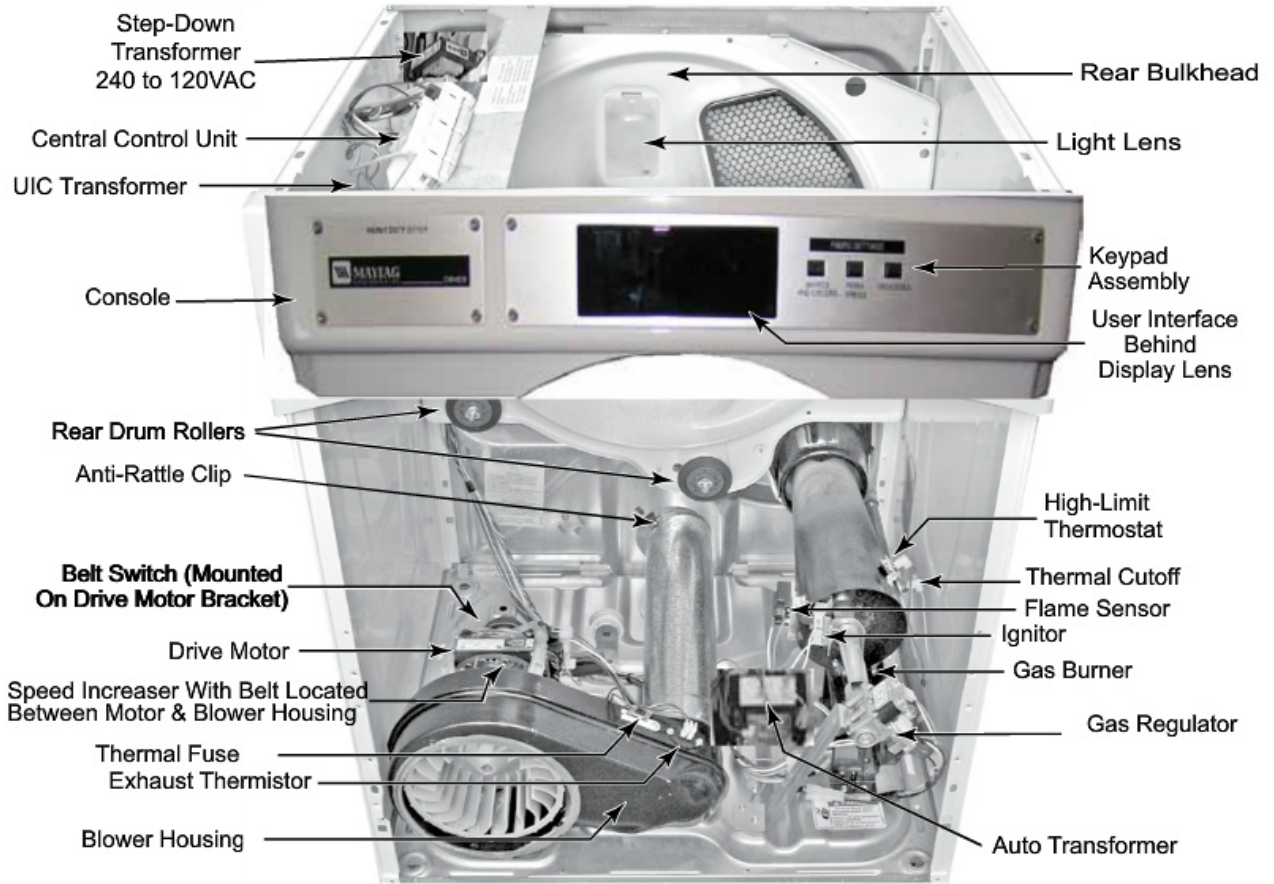

REMOVE FACIA AND DISPLAY LENS - MODEL 22

⚠ WARNING

<p>Electrical Shock Hazard Disconnect power before servicing. Replace all parts and panels before operating. Failure to do so can result in death or electrical shock.</p>

TECH TIP: If the facia does not lay flat against the front of the dryer, the gap can be corrected by applying double stick tape to the back of it, or by putting a reverse bow on the facia before reinstalling it on the dryer.

NOTE: Instructions for models with snap-in display lens [\(See page 4-47\)](#).

-  1. Remove the four T-20 security machine screws from the front of the facia.



2. Pull the facia away and remove the display lens from the back of the facia. There may be double stick tape on the back of the facia.
3. To avoid damage, lay a towel, or another covering, on the dryer top and place the facia and display lens, as well as removed hardware and tools, on the covering.
4. When reinstalling the facia, the machine screws must be used, not sheet metal screws found elsewhere on the console assembly.

REMOVE CONTROL PANEL COVER

⚠ WARNING



Electrical Shock Hazard
 Disconnect power before servicing.
 Replace all parts and panels before operating.
 Failure to do so can result in death or electrical shock.

1. Remove fascia (See page 4-2).

 2. Remove four T-20 security screws from name plate.

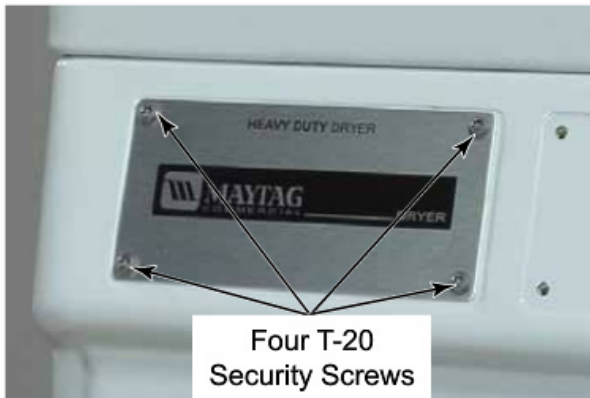

3. Pull control panel cover away from front of dryer.



OPEN DRYER TOP

⚠ WARNING



Electrical Shock Hazard
 Disconnect power before servicing.
 Replace all parts and panels before operating.
 Failure to do so can result in death or electrical shock.

1. Remove control panel cover (See page 4-3).

 2. Remove two 1/4" hex head screws in the upper front corners behind control panel cover.

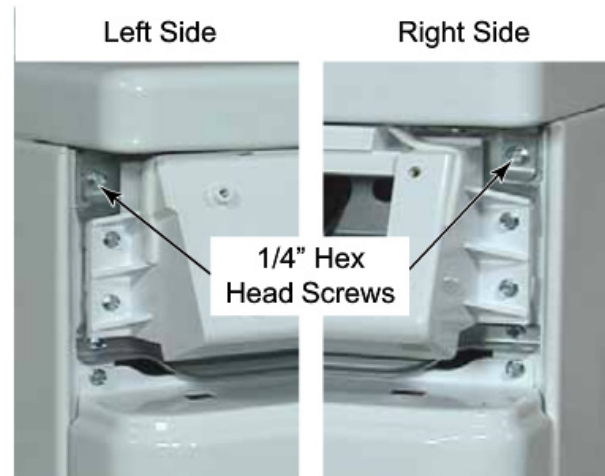

3. Lift the front edge of top to open.

4. When it is open all the way, the top will rest on two retaining supports attached to back of dryer just below the top.

5. The two hinges attached to the top are secured with Star head screws that are hidden once top is closed.

REMOVE CONTROL PANEL

⚠ WARNING



Electrical Shock Hazard
Disconnect power before servicing.
Replace all parts and panels before operating.
Failure to do so can result in death or electrical shock.

1. Open dryer top (See page 4-3).

 2. Remove two T-20-1/4" hex head screws from each end of control panel.

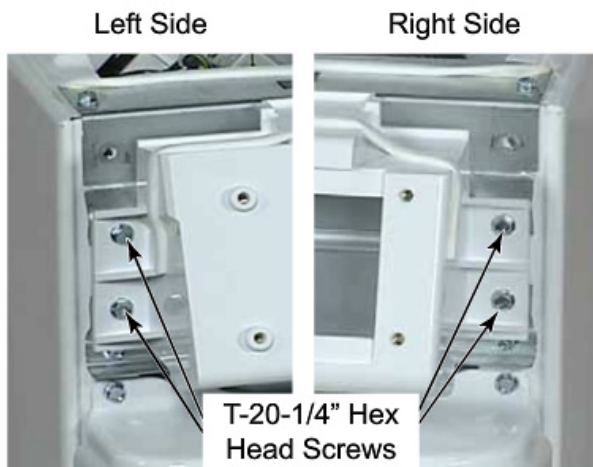

3. Lift control panel up to release two tabs from the upper edge of the dryer.

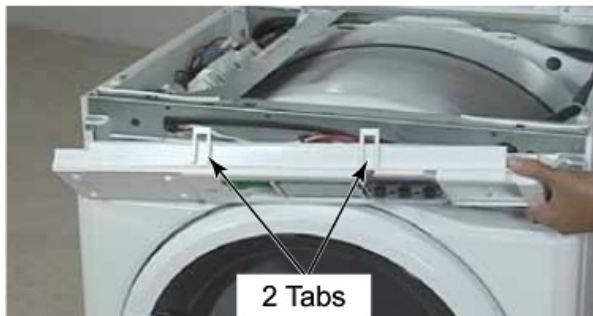

4. Disconnect wire harness Rast connector from the CCU to UIC.
5. Disconnect key pad ribbon connector by gently pulling it out of the connector.
6. Disconnect transformer wire connector at AA6.
7. Disconnect service switch wire connector at AA1 for PD models.
8. Disconnect coin 1 wire connector at AA4.
9. Disconnect coin 2 wire connector at AA5.
10. Disconnect Earth wire. Depress locking tab and pull connector off the spade, which is secured to the control panel with a screw.

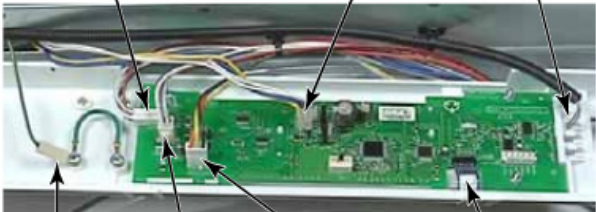
11. Remove control panel.
- 
- Coin 2 AA5
Transformer AA6
CCU to UIC
- Earth Wire
Coin 1 AA4
Service Switch AA1
Push Button Ribbon Connector

TECH TIP: The extra length of plastic at the end of the ribbon connector must be bent back over the top of the end of the ribbon connector, not down and under or it will block the connections preventing operation.

REMOVE KEYPAD ASSEMBLY

⚠ WARNING



Electrical Shock Hazard
Disconnect power before servicing.
Replace all parts and panels before operating.
Failure to do so can result in death or electrical shock.

1. Remove control panel (See page 4-4).

 2. Remove two 5/16" hex head nuts that also help secure the control board.



3. Slide the bolts out of the holes in the front of the control panel.

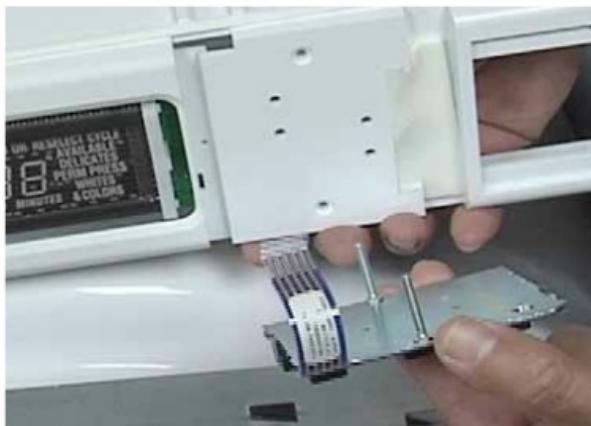

4. To remove buttons from subassembly, release locking tab on back side of subassembly. The other end simply slides out of a slot in the backer plate.

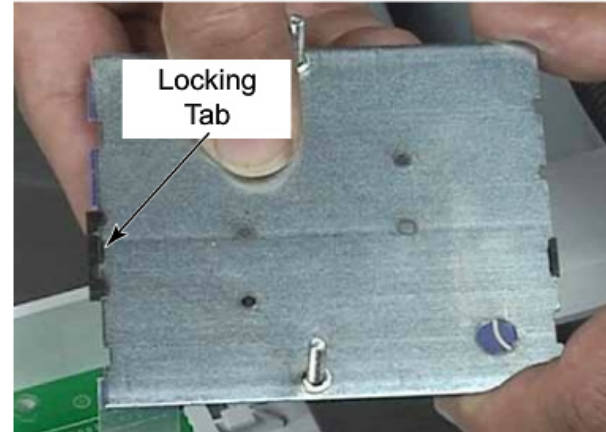

TECH TIP: To reinstall buttons, mount button assembly in upper slots of the subassembly. The ribbon connector is on the upper edge.

The hinge end of button assembly should be toward the top with the free end of the button hanging down toward the bottom edge of the subassembly.

The pads of the buttons are aligned with the lower row of pads on membrane switch.

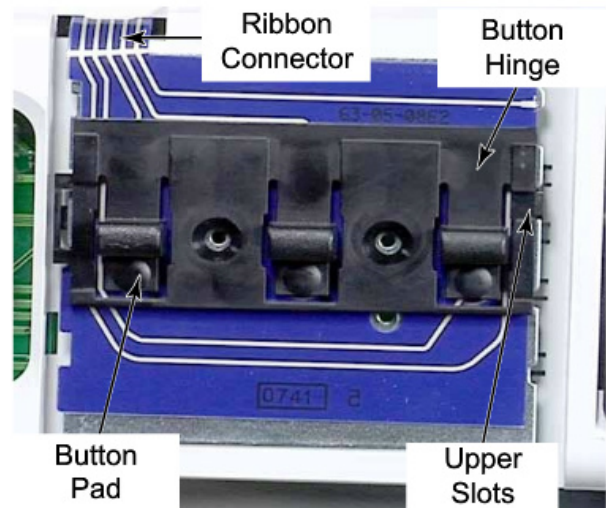

REMOVE USER INTERFACE CONTROL BOARD (UIC)

⚠ WARNING



Electrical Shock Hazard
Disconnect power before servicing.
Replace all parts and panels before operating.
Failure to do so can result in death or electrical shock.

1. Remove control panel (See page 4-4).

 2. Remove two #1 star head screws from one end of the UIC.

NOTE: These screws attach to plastic posts so make sure not to overtighten when reinstalling control board.

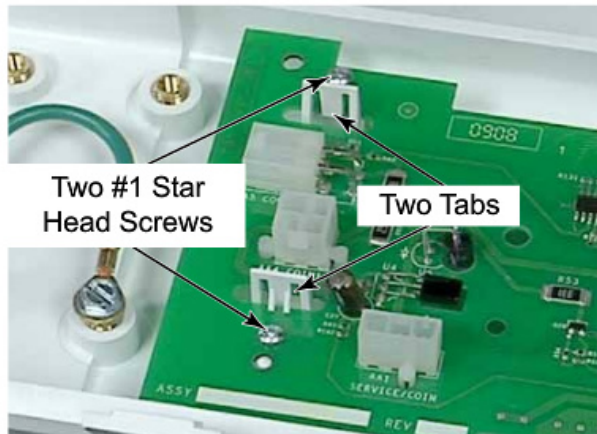

3. Squeeze two tabs together and lift the board up from the tab end. Remove control board by sliding it out from under the edge where the Rast connectors connect to it.

TECH TIP: Connector J1 on the control board is for programming software onto the board. The jumper pins at J2 must be jumped for reprogramming and left open when in normal use.

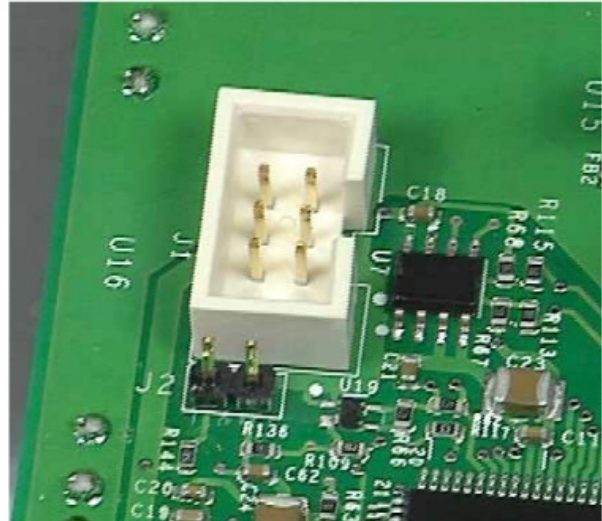

REMOVE CCU MOUNTING BRACKET

⚠ WARNING

<p>Electrical Shock Hazard Disconnect power before servicing. Replace all parts and panels before operating. Failure to do so can result in death or electrical shock.</p>

1. Open dryer top (See page 4-3).

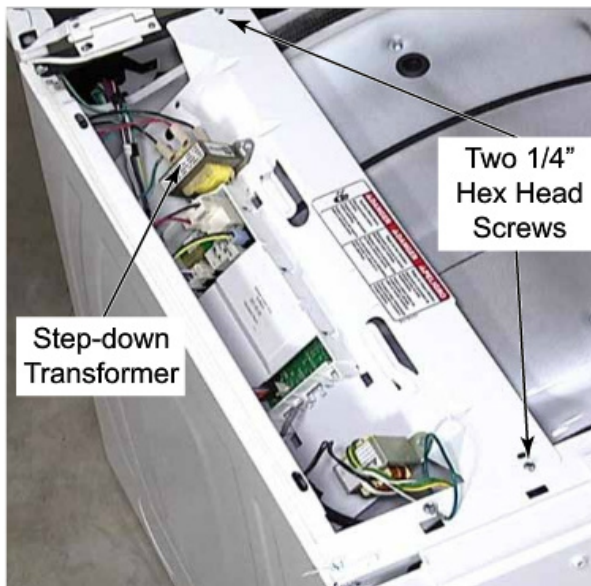
 2. Remove the 1/4" hex head screw from each end of bracket.



3. Set bracket on the top of the drum.

4. On Model 22 dryers, remove the UIC transformer and the step-down transformer. (See page 4-8).

5. On Model 25 dryers, there is no step-down transformer. Remove the UIC transformer (See page 4-8).



6. Remove the CCU (See page 4-9).

REMOVE UIC & STEP-DOWN TRANSFORMERS

⚠ WARNING



Electrical Shock Hazard
Disconnect power before servicing.
Replace all parts and panels before operating.
Failure to do so can result in death or electrical shock.

1. Open dryer top (See page 4-3).
2. Disconnect transformer wire connector at AA6 on the UIC (Illustration page 4-4).
3. Pull the wires through the opening in the front of the dryer
4. Disconnect power wire to transformer. It may be necessary to use a small flat blade screwdriver to release the locking tab inside the connector.

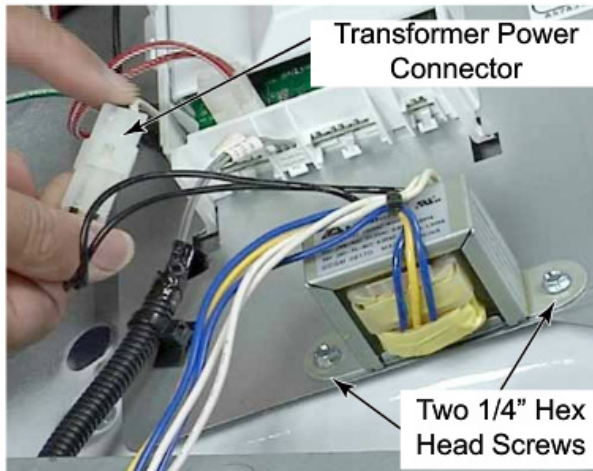

5. Remove two 1/4" hex head screws that secure the transformer to the bracket and remove transformer.

NOTE: The screws for the transformer are shorter than other 1/4" hex head screws used in the dryer so the screw will not touch the drum below the bracket.



NOTE: To avoid damage to transformer and dryer from power surges, the transformer has an internal fuse on its primary leg.

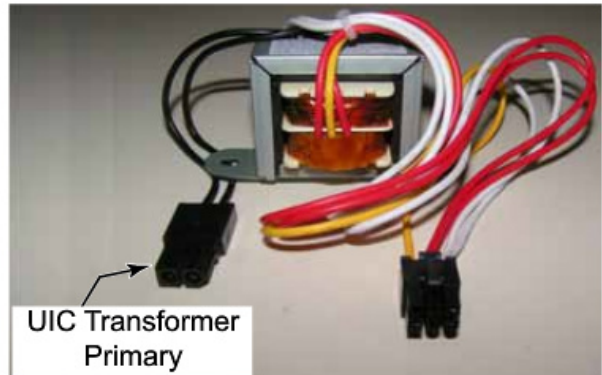

6. On model 22 dryers: Remove step-down transformer by removing the three wire connectors and two 1/4" hex head screws.



REMOVE CENTRAL CONTROL UNIT (CCU)

⚠ WARNING



Electrical Shock Hazard
Disconnect power before servicing.
Replace all parts and panels before operating.
Failure to do so can result in death or electrical shock.

1. Open dryer top (See page 4-3).

 2. Disconnect CCU to UIC Rast connector.

3. Disconnect P14 wire connector by depressing the tab and pulling Connector off the control.

4. Disconnect P8 wire connector by depressing two locking tabs and pulling connector off the control.

5. Disconnect P9 wire connector by pulling connector off the control.

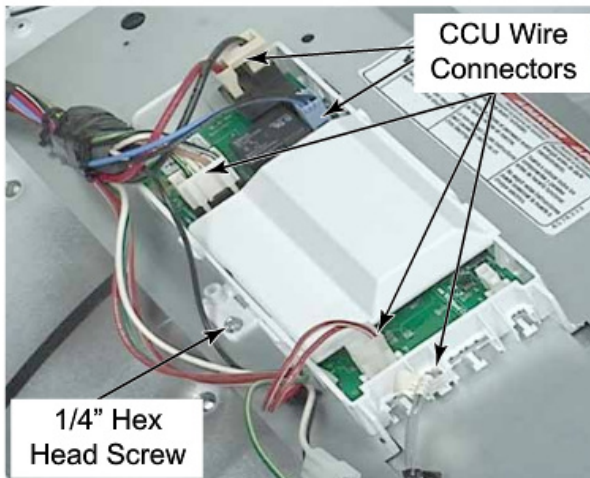

6. Disconnect K2 relay wire connector by pulling connector off the control.

7. Remove the 1/4" hex head screw that secures CCU to the bracket.

8. Turn bracket over and press the locking tab on the bottom of the bracket.

9. Slide the CCU sideways to release tabs from slots and lift CCU off the bracket.

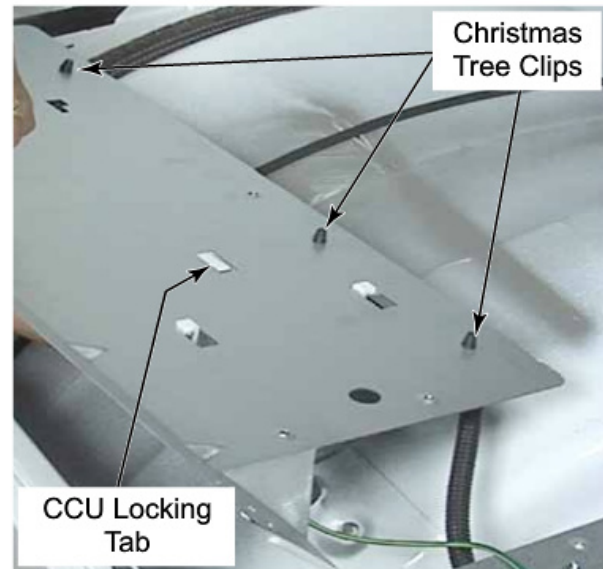

10. Use a pair of pliers to squeeze three Christmas tree clips and push them through to the front of the bracket to release wire ties from the bracket and remove it.

REMOVE CONTROL PANEL BRACKET

⚠ WARNING

<p style="text-align: center;">Electrical Shock Hazard Disconnect power before servicing. Replace all parts and panels before operating. Failure to do so can result in death or electrical shock.</p>

1. Remove control panel (See page 4-4).

 2. Remove four 1/4" hex head screws that secure the control panel bracket to the side panels.



3. Lift control panel bracket and turn it over setting it on the dryer drum.

4. Use a pair of pliers to squeeze two Christmas tree clips to release wire ties from the bracket.



5. Pull wires through the holes in bracket and remove it.

REMOVE DRYER TOP

⚠ WARNING

<p style="text-align: center;">Electrical Shock Hazard Disconnect power before servicing. Replace all parts and panels before operating. Failure to do so can result in death or electrical shock.</p>

-  1. Open service access door on the top of the metercase.



2. Disconnect coin drop, coin vault switch and service access switch wire connectors.
3. Use a pair of pliers to squeeze the Christmas tree clip in the bottom of service access area of the metercase to release the wire tie from under the top.
4. Open dryer top (See page 4-3).

5. Pull wires through the hole in the top.



-  6. Remove two #2 star head screws from each hinge where they are attached to the top.

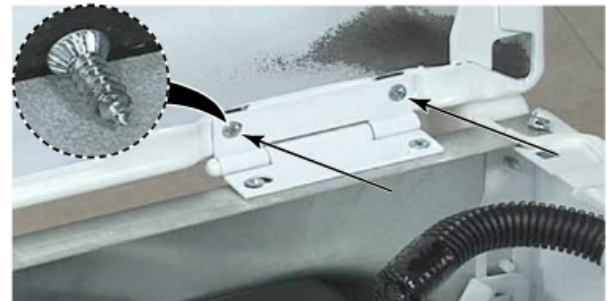

NOTE: These screws are different than most other screws in the dryer in that the head is tapered and serrated. They are shorter than most other screws as well.

7. Support the top when removing the screws.
8. Lift top off dryer.



REMOVE DRYER DOOR

⚠ WARNING



Electrical Shock Hazard

Disconnect power before servicing.

Replace all parts and panels before operating.

Failure to do so can result in death or electrical shock.

-  1. Open dryer door.



2. Loosen but do not remove the second screw down from the top of the door hinge.

NOTE: On model 22 dryers or dryers with doors that do not open 180 degrees, the hole for this screw is snowman shaped which will allow the screw to pass through it when lifting door off dryer. If door has been reversed and hinge is mounted on the left side of the dryer, then the hinge is upside down and the snowman hole will not support the door when the screw is loosened.

3. Remove the remaining three star head screws that secure the door hinge to the dryer front panel.
4. After removing three and loosening one screw, grasp the door and pull the hook of the hinge out of the slot in front panel, then lift door hinge off the remaining screw.

NOTE: These screws are tapered and serrated like the hinge screws for the dryer top, but they are larger than those for the top hinges. Serrated head helps keep screws tight without a lock washer.



NOTE: Instructions for models with 180° opening door hinge (See page 4-46).

REVERSE DRYER DOOR

⚠ WARNING



Electrical Shock Hazard
Disconnect power before servicing.
Replace all parts and panels before operating.
Failure to do so can result in death or electrical shock.

1. Remove dryer door (See page 4-12).

 2. Remove door strike by removing the star head pan screw.

3. Rotate top of the strike away from dryer and slide tab out of slot in dryer front panel.

4. Turn strike 180° to install it on the opposite side of door opening.

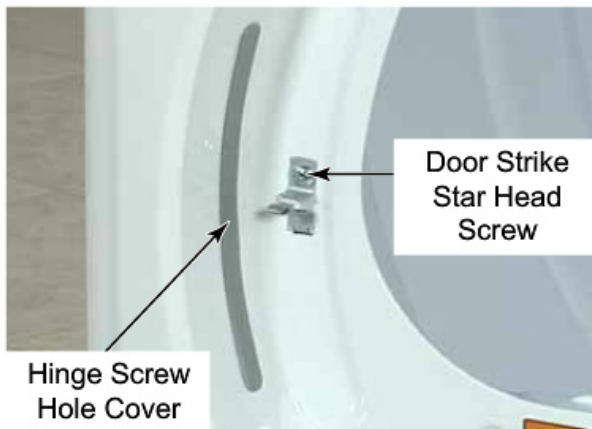

5. Install hinge screw hole cover on opposite side of door opening. Align two pins on the back of cover with the two middle holes for the door hinge screw holes.



6. Press pins into holes as far as they will go.

7. Separate door halves by removing 6 star head screws from the inside door panel.

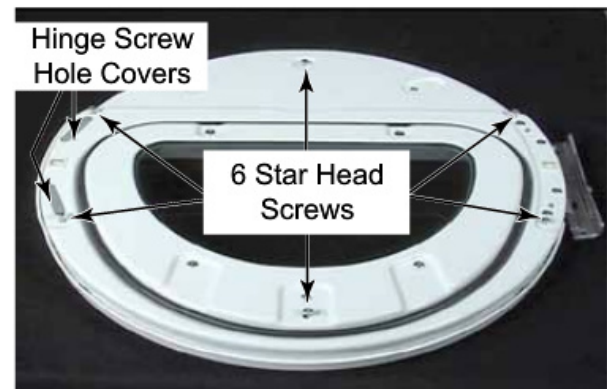

8. Lift inside door half off outside door half.

9. Remove two hinge screw hole covers by gently prying two plastic pins out of the holes for each cover .

10. Remove four star head screws that secure the hinge to the door.

11. Move hinge to other side and attach it with four screws just removed. There are two placement pins in the hinge that fit into two holes for correct hinge placement.

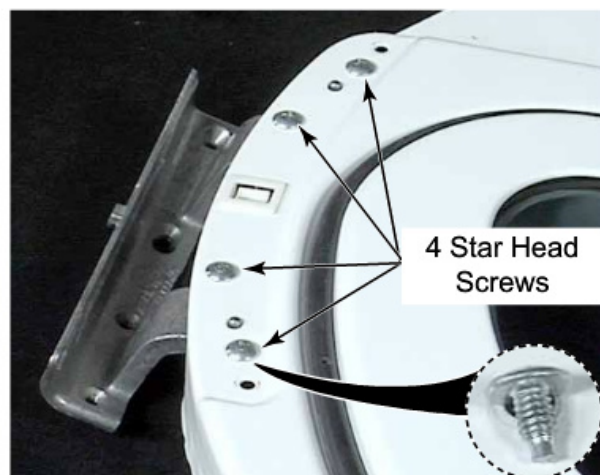

12. Install hinge screw hole covers where hinge was removed from. Align two pins on back of cover with two holes for the door hinge screws. Press pins into holes as far as they will go.

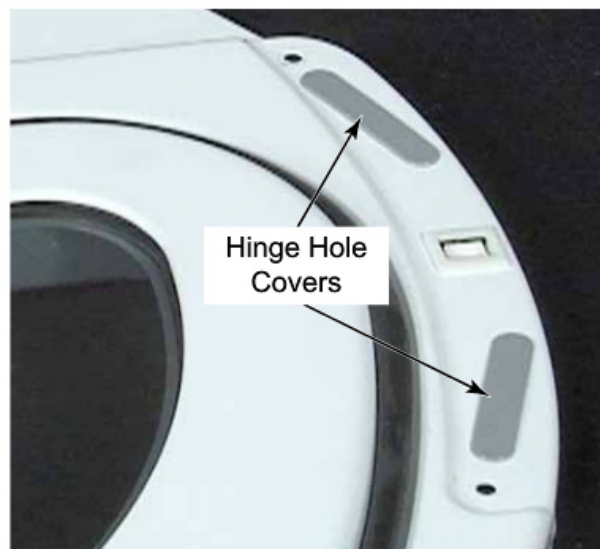

13. Rotate outer door 180° to place handle on the opposite side of hinge

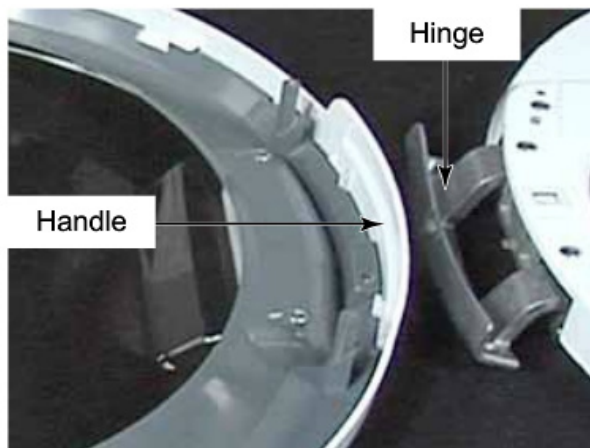

location.

14. Place inner door into outer door with hinge opposite the handle side.

15. Reinstall 6 star head screws in the door.

NOTE: The longest screw goes in the hole at the top of the door. These screws have high and low threads for holding in plastic.

REMOVE DOOR HANDLE

1. To remove door handle after door halves are separated (See page 4-13). Remove 3 star head screws.

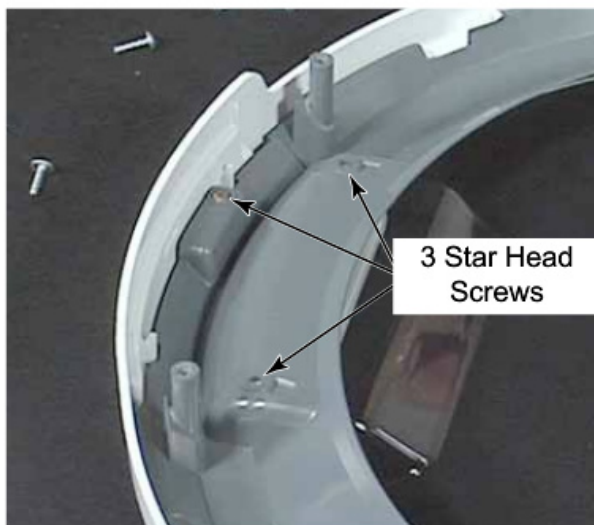

2. Use a flat blade screwdriver to press in on plastic tab on the inside of the door handle.

3. Pull handle away from the door.



REMOVE INNER DOOR SUPPORT

1. Separate door halves (See page 4-13).
2. Remove door handle (See left column on this page).
3. Rotate inner lens slightly to release tabs that secure the inner lens to the front door half and lift lens out of door trim.



REMOVE DRUM LIGHT LENS

⚠ WARNING

<p>Electrical Shock Hazard Disconnect power before servicing. Replace all parts and panels before operating. Failure to do so can result in death or electrical shock.</p>

1. Open dryer door.

 2. Remove screw from drum light lens.

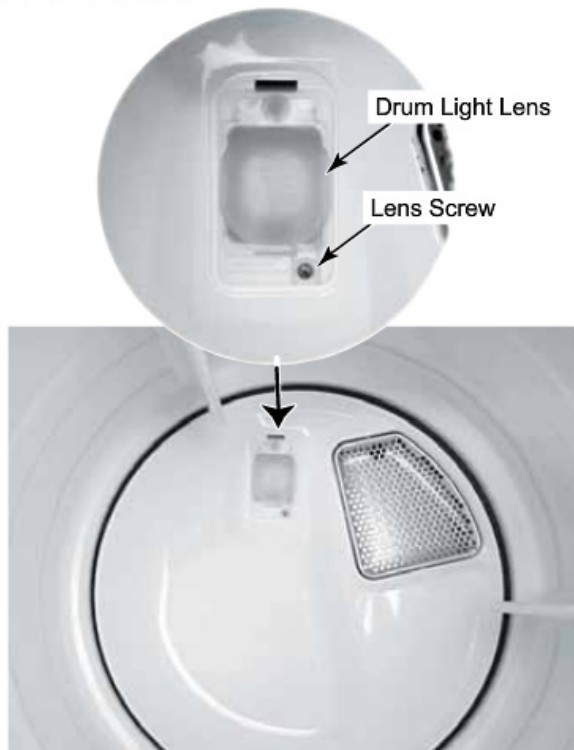
3. Remove lens.



NOTE: There is no light socket on a commercial dryer, nor is there capability of adding a light on commercial dryers. The lens is maintained as a safety device.

REMOVE SERVICE PANEL

⚠ WARNING

<p>Electrical Shock Hazard Disconnect power before servicing. Replace all parts and panels before operating. Failure to do so can result in death or electrical shock.</p>

 1. Remove two 1/4" hex head screws from the bottom corners of the service panel.



2. Pull service panel out from the lower edge and allow panel to drop down to release top edge from dryer and remove service panel.



3. Tech sheet, parts list and wiring diagrams are located behind the service panel.

REMOVE FRONT PANEL

⚠ WARNING



Electrical Shock Hazard
Disconnect power before servicing.
Replace all parts and panels before operating.
Failure to do so can result in death or electrical shock.

1. Open dryer top (See page 4-3).

 2. Open dryer door and remove lint filter.

3. Remove 2 star head screws below door opening that secure the front panel to the lint filter housing. These screws are large pan head screws. Close dryer door.



4. Remove service panel (See page 4-16).

5. Remove two 1/4" hex head screws that secure bottom of front panel to the dryer.



6. Remove two 1/4" hex head screws that secure the top of the front panel to the dryer.



7. Pull front panel away from dryer and rotate it to access the door switch wire connectors.

 8. On Model 22 dryers, use a small flat blade screwdriver to release the wire to the door switch from strain relief on lint filter housing.

NOTE: On model 25 dryers use a pair of pliers to squeeze the Christmas tree clip to release strain relief from lint filter housing.

9. Use a flat blade screwdriver to release the locking tab and disconnect the door switch wire connector.

10. Remove door switch by pressing locking tabs on both sides of door switch from inside the front panel and rotating the switch out the front, pulling the wires out through hole with switch.

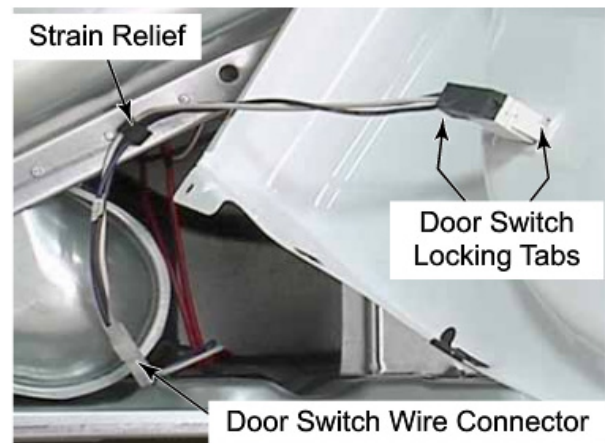

REMOVE LINT FILTER HOUSING

⚠ WARNING



Electrical Shock Hazard
Disconnect power before servicing.
Replace all parts and panels before operating.
Failure to do so can result in death or electrical shock.

1. Open dryer door and remove lint filter.
2. Remove service panel (See page 4-16).
3. On Model 22 dryers release door switch wire harness strain relief. On Model 25 dryers release the Christmas tree clip from lint filter housing.
4. Remove four 1/4" hex head screws. The two screws going into the blower housing are brass and must be reinstalled in the same location they are removed from.

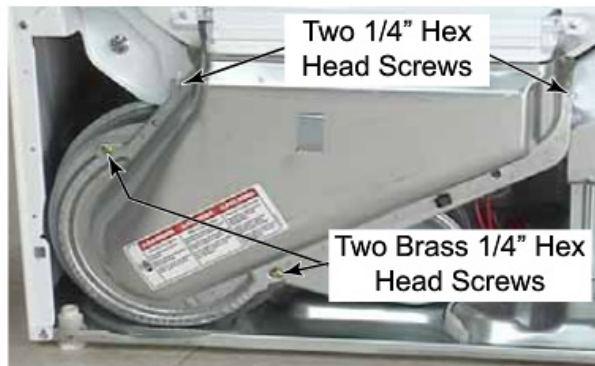

5. Pull lint filter housing away from dryer.

TECH TIP: Excess blower vibration may be reduced by loosening the upper left brass screw in the lint filter housing up to two full turns. Make sure the foam insulation blocks any gaps, add more foam insulation or aluminum duct tape to seal up any gaps.

REMOVE FRONT BULKHEAD

⚠ WARNING



Electrical Shock Hazard
Disconnect power before servicing.
Replace all parts and panels before operating.
Failure to do so can result in death or electrical shock.

1. Remove front panel (See page 4-17).
2. Remove lint filter housing (See left column on this page).
3. Remove two 1/4" hex head screws from bottom corners of bulkhead.
4. Loosen, but do not remove, two 1/4" hex head screws from top corners of bulkhead.



5. Lift front bulkhead enough so upper screws can pass through the lower snowman holes and pull it away from dryer.

NOTE: After front bulkhead is removed, do not move the dryer or serious damage may occur to the side panels.

REMOVE OUTLET GRILL

⚠ WARNING

<p style="text-align: center;">Electrical Shock Hazard Disconnect power before servicing. Replace all parts and panels before operating. Failure to do so can result in death or electrical shock.</p>

1. Open dryer door and remove lint filter.

 2. Remove 3 star head screws.

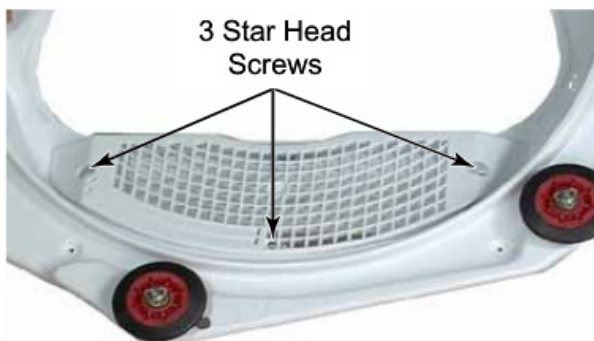
NOTE: The middle screw is shorter than the other two. The outer two screws are large pan head screws, longer than any other star head screws in dryer.



3. Lift outlet grill off front bulkhead.

4. Separate the two halves of the outlet grill by pulling them apart.



5. The lint filter door has a spring on one end of the door that keeps it closed when filter is not in place.

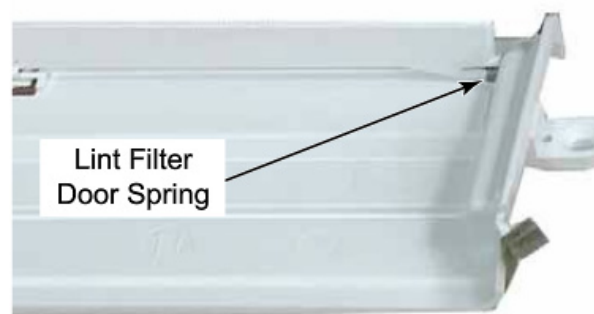

REMOVE DRUM SUPPORT ROLLERS AND SHAFTS

⚠ WARNING



Electrical Shock Hazard
Disconnect power before servicing.
Replace all parts and panels before operating.
Failure to do so can result in death or electrical shock.

1. Remove front bulkhead (See page 4-18).

 2. Two front support rollers are mounted to the front bulkhead on shafts.

3. Remove tri-clip from shaft and slide support roller off shaft.



4. There is another tri-clip behind the roller for proper spacing.



NOTE: When replacing a roller, always replace both tri-clips to make sure that roller will stay in position while running.

NOTE: DO NOT lubricate this wheel or shaft. Clean shaft with fine steel wool to eliminate squeaks, or replace worn roller supports.

5. Support roller shafts are secured to the front bulkhead with 9/16" nuts and a washer.



6. The washer is installed on the roller side of the shaft.



NOTE: To support the roller shaft while trying to remove the 9/16" shaft a Vice Grip needs to be used to hold the nipple on the front of the roller shaft.



REMOVE DRUM BAFFLE

⚠ WARNING

<p style="text-align: center;">Electrical Shock Hazard Disconnect power before servicing. Replace all parts and panels before operating. Failure to do so can result in death or electrical shock.</p>

1. Remove dryer top (See page 4-11).

 2. Remove two of the three 1/4" hex head screws that secure baffle to drum.



3. These screws have multiple thread depths that grab plastic securely to help avoid screws becoming loose from vibration.



4. Open dryer door and hold baffle with one hand while removing the third screw.

5. Remove baffle from dryer and replace if necessary.

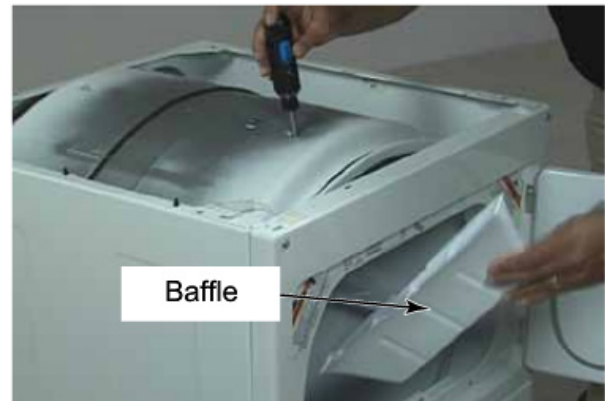

REMOVE DRYER DRUM

⚠ WARNING



Electrical Shock Hazard
Disconnect power before servicing.
Replace all parts and panels before operating.
Failure to do so can result in death or electrical shock.

1. Remove front bulkhead (See page 4-18).

 2. Reach in under the drum and lift idler pulley to release tension on belt.

3. Remove belt from idler pulley and then remove it from the motor pulley.

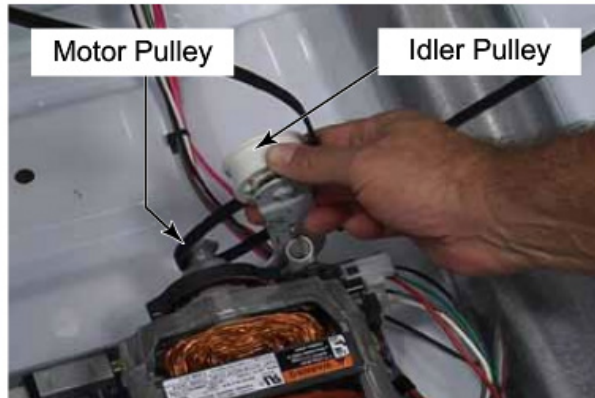

4. Remove belt from dryer. The belt can be reinstalled in the same manner as it was removed without removing drum from dryer.

The belt is a multi-ribbed belt that is not interchangeable with the household belt. When reassembling dryer make sure the ribs of the belt are facing the drum.

5. The dryer drum is installed with the drum clip, plug or hole, closer to the bulkhead at the rear of the dryer. This is opposite the orientation of drum in dryer that matches the top load washer. The support rollers roll in this direction without a thump, as they roll from the higher side to the lower side of the welded seam of the drum

The belt does not ride in the groove on the drum, which is called the belly band. There is adequate clearance between the belt and the top of the dryer so it does not need to ride in the lower part of the belly band.

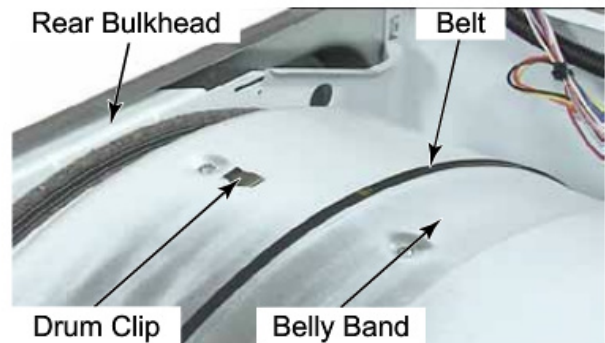

6. To remove a drum clip or plug, use a flat blade screwdriver to lift edge of clip and remove it from drum.

7. Grasp drum and pull it out of the cabinet.



8. Front and rear drum seals are felt, they are glued into place. Watch for pins or other user items stuck in the felt while handling and removing the drum.

REMOVE BLOWER WHEEL

⚠ WARNING

<p>Electrical Shock Hazard Disconnect power before servicing. Replace all parts and panels before operating. Failure to do so can result in death or electrical shock.</p>

1. Remove dryer drum (See page 4-22).
2.  Place a 7/8" wrench on the motor drum belt pulley to stop motor shaft from turning.
3. Use a 1/2" ratchet extension bar to turn blower wheel clockwise to remove it. The blower wheel has arrows and words to show the correct direction to turn the wheel to remove or tighten it.



4. To remove blower wheel when a speed increaser belt is broken, slipping or missing, a thin 7/16" open end wrench will be needed to secure speed increaser shaft on its flat spot, in lieu of securing motor pulley.

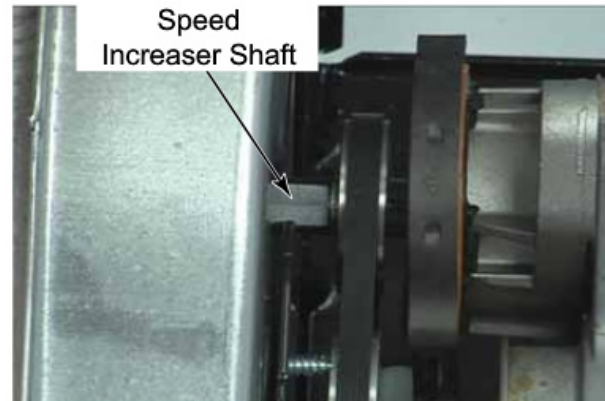

TECH TIP: When removing blower wheel, move 1/2" extension bar in a quick jerking motion rather than applying slow pressure, to help avoid rounding of the center hole of blower wheel, which could stress and crack the blower wheel.

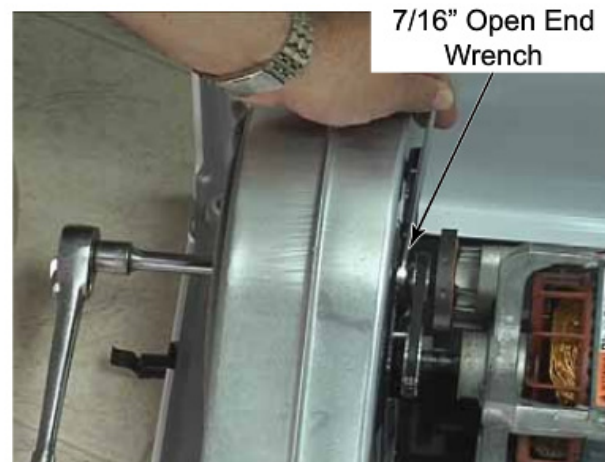

REMOVE THERMISTOR

⚠ WARNING

<p>Electrical Shock Hazard Disconnect power before servicing. Replace all parts and panels before operating. Failure to do so can result in death or electrical shock.</p>

1. Remove lint filter housing
(See page 4-18).

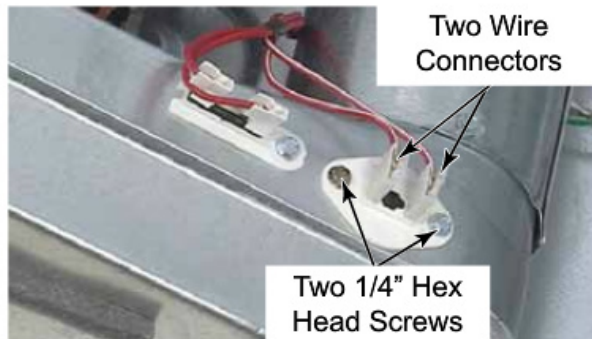
2. Remove two wire connectors from thermistor.



3. Remove two 1/4" hex head screws and remove thermistor.

NOTE: The resistor mounted in the thermistor changes resistance as heat changes. The electronic control can determine the operating temperature of the dryer based on the resistance being read from the thermistor.

REMOVE THERMAL FUSE

⚠ WARNING

<p>Electrical Shock Hazard Disconnect power before servicing. Replace all parts and panels before operating. Failure to do so can result in death or electrical shock.</p>

1. Remove lint filter housing
(See page 4-18).

2. Remove two wire connectors from thermal fuse.

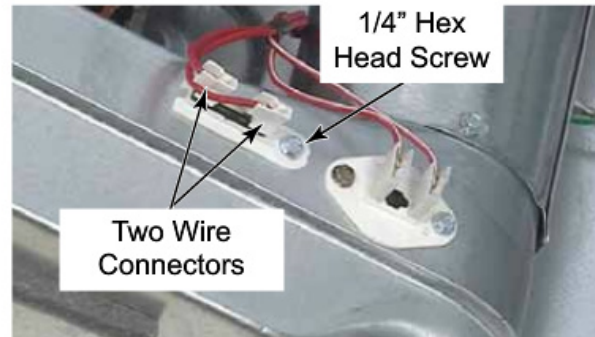
3. Remove the 1/4" hex head screw, lift and slide to release the hook from the other end that secures the thermal fuse to the blower housing.



REMOVE BLOWER HOUSING

⚠ WARNING



Electrical Shock Hazard
Disconnect power before servicing.
Replace all parts and panels before operating.
Failure to do so can result in death or electrical shock.

1. Remove blower wheel (See page 4-23).
2. Remove wire connectors from thermistor and thermal fuse (See page 4-24).
3. Remove the short 1/4" hex head screw that secures blower housing to the exhaust duct.

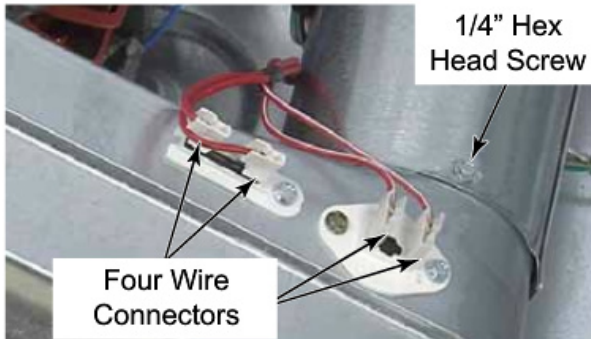

4. Remove three 1/4" hex head screws from inside the blower housing that secure it to the motor bracket.

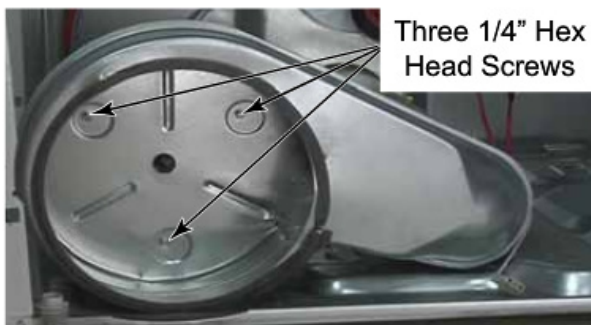

REMOVE BROKEN BELT SWITCH

⚠ WARNING



Electrical Shock Hazard
Disconnect power before servicing.
Replace all parts and panels before operating.
Failure to do so can result in death or electrical shock.

1. Remove dryer drum (See page 4-22).
2. Remove 2 star head screws from back of motor bracket.

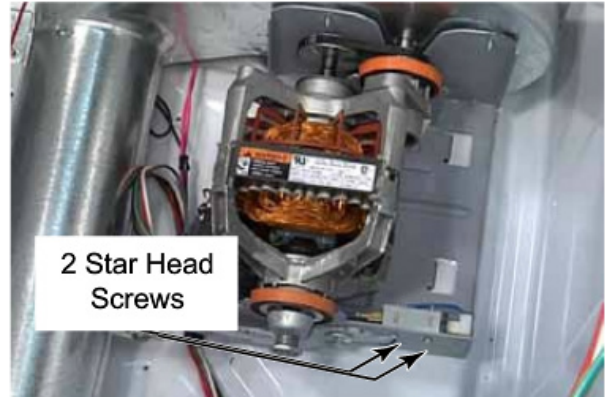

3. Remove two wire connectors and remove broken belt switch switch.

REMOVE EXHAUST DUCT

⚠ WARNING



Electrical Shock Hazard
Disconnect power before servicing.
Replace all parts and panels before operating.
Failure to do so can result in death or electrical shock.

1. Remove blower housing (See page 4-25).

 2. Slide exhaust duct out the front of the dryer.



NOTE: If blower housing and drum have yet to be removed, remove the short 1/4" hex head screw that secures exhaust duct to blower housing. Pull exhaust duct out the rear of the dryer.

TECH TIP: When reinstalling exhaust duct, or for new dryer installations, make sure the anti-vibration clip for the exhaust duct is installed on back panel of dryer. To install clip, slide long leg of clip into dryer along the exhaust duct. Insert tab of clip in square hole above exhaust duct and press handle of clip down until it clicks into place.

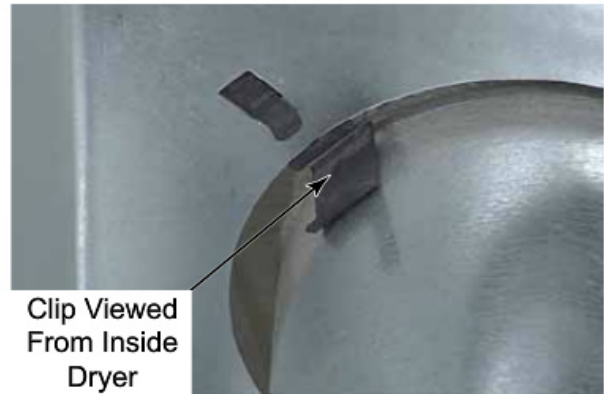

REMOVE DRYER MOTOR

⚠ WARNING



Electrical Shock Hazard
Disconnect power before servicing.
Replace all parts and panels before operating.
Failure to do so can result in death or electrical shock.

1. Remove dryer drum (See page 4-22).
2. Remove blower wheel (See page 4-23).
-  3. Remove motor bracket clips by placing a nut driver on the end tip of the clip and pressing down and toward motor until clip pops off the hook of the bracket. Remove both front and rear clips.

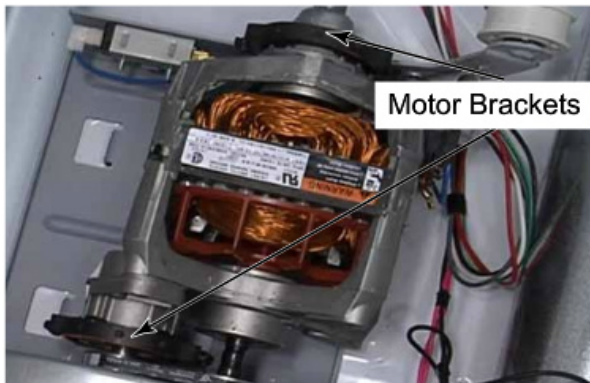

4. Disconnect 3 motor wires; red, blue, and white, from connectors on the motor switch.

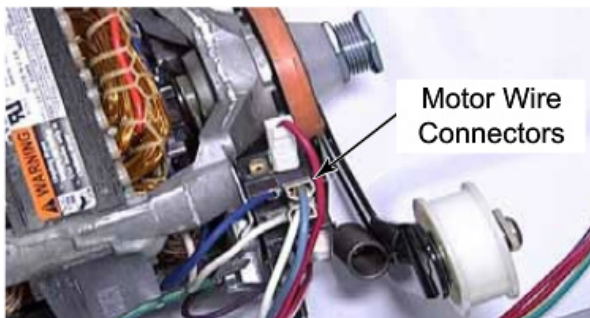

5. Remove the Earthing clip from the motor frame. This will allow the motor to be rotated enough to remove red wire with a white stripe from the bottom of the motor switch.



NOTE: There is a legend on the far side of the motor switch to assist in placement of the removed wires during reinstallation of the motor.

6. Lift motor out of the cabinet with speed increaser attached.



TECH TIP: When replacing a complete motor for a wiring or a bearing issue not related to the speed increaser, it would be prudent to remove and keep the speed increaser assembly for future repair needs. This could save the expense of replacing another motor if a speed increaser fails.

REMOVE MOTOR BRACKET

⚠ WARNING

<p>Electrical Shock Hazard Disconnect power before servicing. Replace all parts and panels before operating. Failure to do so can result in death or electrical shock.</p>

1. Remove motor (See page 4-27).

 2. Remove two 1/4" hex head screws that secure the bracket to base of dryer.

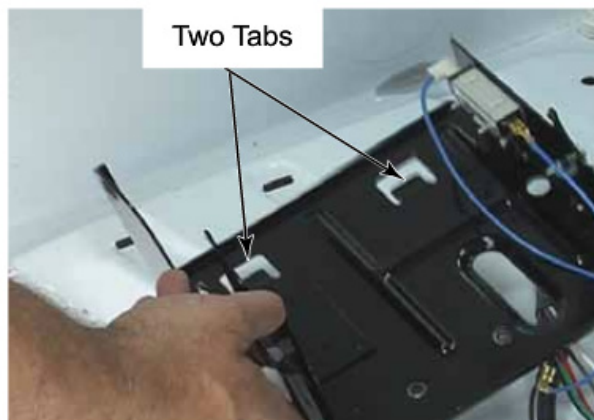

3. Lift bracket to remove two tabs that pass through dryer base and remove bracket from dryer.



TECH TIP: To reduce excess vibration transferred from the motor bracket to the cabinet, place anti-vibration pads, if they are missing, under the motor bracket. Install two pads if possible, or if only one is available then center it below the bracket.

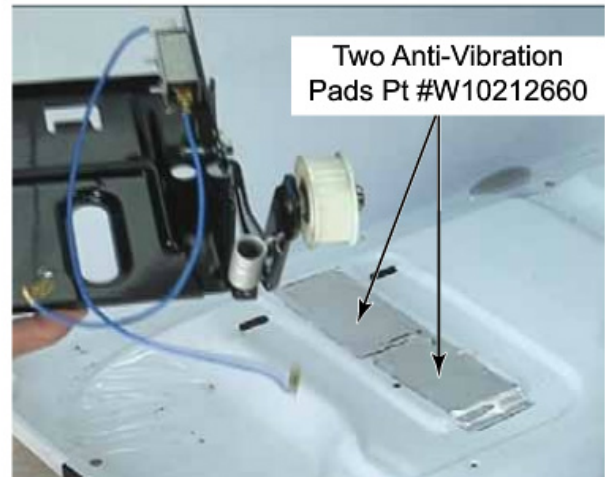

REMOVE IDLER ASSEMBLY PARTS

⚠ WARNING



Electrical Shock Hazard

Disconnect power before servicing.

Replace all parts and panels before operating.

Failure to do so can result in death or electrical shock.

1. Remove dryer drum (See page 4-22).

 2. Gently pry tri-clip off idler pulley shaft. Slide wheel off the shaft.

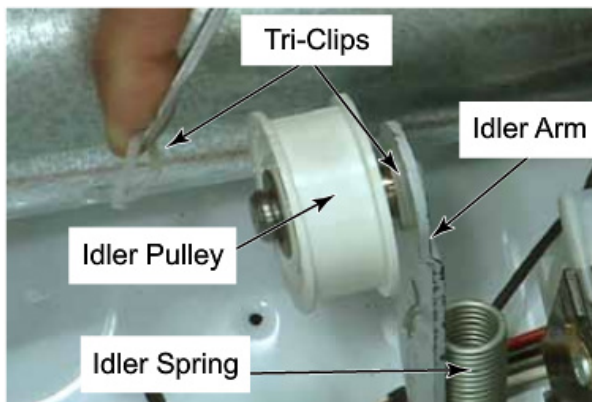

3. There is another tri-clip behind the wheel for proper spacing. Replace both tri-clips when replacing idler pulley.

NOTE: Make sure not to lubricate this wheel or shaft. Clean shaft with fine steel wool to eliminate squeaks, or replace worn roller supports.

4. After mid year 2011, production dryers may have a different idler pulley assembly. This idler assembly must be removed and replaced entirely, which includes pulley and idler arm. This assembly must not be serviced as individual parts due to specific torquing of the nut on the idler pulley bolt.



NOTE: After implementation of this style idler pulley in production, all replacement idler pulleys will be of the type without tri-clips.

5. To remove the Idler arm assembly, remove the belt from the idler wheel if present.

6. Stretch the idler spring and disengage it from the idler arm.

7. Remove the 3/8" screw and shouldered washer that secure the idler arm loosely to the motor bracket.

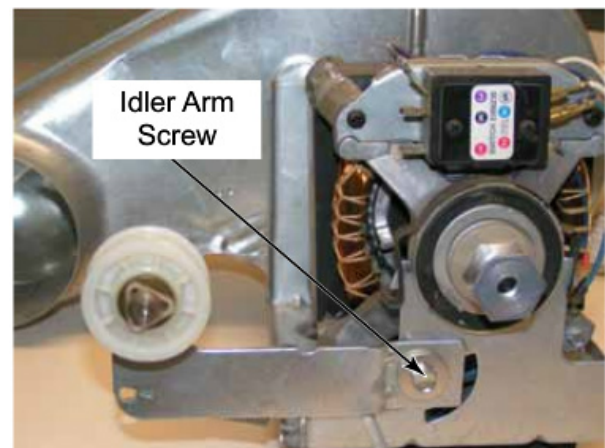

8. Pull the idler assembly out of the notch in the motor bracket.

REMOVE DRUM REAR SUPPORT ROLLERS

⚠ WARNING

<p>Electrical Shock Hazard Disconnect power before servicing. Replace all parts and panels before operating. Failure to do so can result in death or electrical shock.</p>

1. Remove dryer drum (See page 4-22).
-  2. Two rear support rollers are mounted to the rear bulkhead on shafts. Remove the tri-clip from the shaft.



3. Slide support roller off the shaft.
4. There is another tri-clip behind the roller for proper positioning of the roller. When replacing a roller, always replace both tri-clips to make sure that roller will stay in position while running.

NOTE: Make sure not to lubricate this wheel or shaft. Clean shaft with fine steel wool to eliminate squeaks or replace worn roller supports.

REMOVE REAR SUPPORT ROLLER SHAFTS

⚠ WARNING

<p>Electrical Shock Hazard Disconnect power before servicing. Replace all parts and panels before operating. Failure to do so can result in death or electrical shock.</p>

1. Remove the dryer drum (See page 4-22).
2. Remove the two rear support rollers (See page 4-30).

-  3. The two rear support rollers spin on shafts that are secured on the back of the bulkhead with a 9/16" nut. Care needs to be taken when removing the support roller shaft, as gripping the shaft with a Vice Grip or pliers may damage the bearing surface and cause noisy rollers and premature failure of roller supports.



NOTE: To support the roller shaft while trying to remove the 9/16" shaft a Vice Grip needs to be used to hold the nipple on the front of the roller shaft.



REMOVE REAR PANEL

⚠ WARNING



Electrical Shock Hazard
Disconnect power before servicing.
Replace all parts and panels before operating.
Failure to do so can result in death or electrical shock.

1. Remove dryer top (See page 4-11).

 2. Remove the 1/4" hex head screw that secures the electrical connections cover to the rear panel.

3. On electric heat models, disconnect power cord from terminal block connections. On gas heat models, lift the power cord retainer clip off the power cord bushing, disconnect the power cord connector.

4. Remove the 5/16" hex head screw that secures Earthing cable to rear panel.

5. Remove 2 star head pan screws that secure the terminal block to the rear panel.

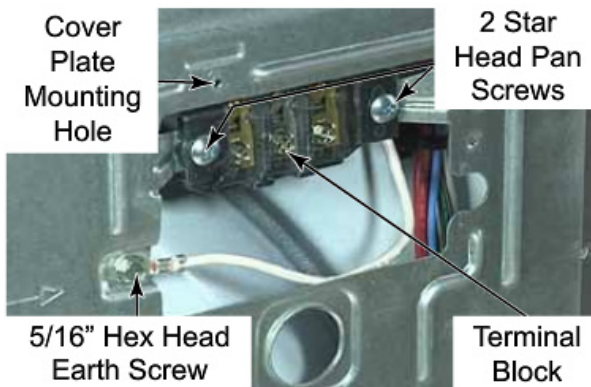

6. Remove ten 1/4" hex head screws that secure the rear panel to the dryer.



7. Peel end of insulation strip off of upper edge of rear panel, leaving it attached to upper edge of side panel, so that it does not tear when removing rear panel.



8. Pull rear panel straight away from dryer until exhaust duct is out of its hole, and remove rear panel.

REMOVE DRYER SIDE PANEL (LEFT SIDE SHOWN)

⚠ WARNING



Electrical Shock Hazard
Disconnect power before servicing.
Replace all parts and panels before operating.
Failure to do so can result in death or electrical shock.

1. Remove dryer drum (See page 4-22).
2. Remove rear panel (See page 4-31).

3. Remove the 1/4" hex head screw in lower front left corner of dryer.



4. Remove two 1/4" hex head screws from lower back edge of side panel, one from the corner in to the base and one above that in to rear bulkhead.



5. Support side panel and lift rear bulkhead and move it forward to release hook from the back edge of the side panel.



6. Lay side panel down while continuing to support rear bulkhead.

7. To completely remove side panel, lift base of dryer to release two tabs of the side panel from two slots in the base.

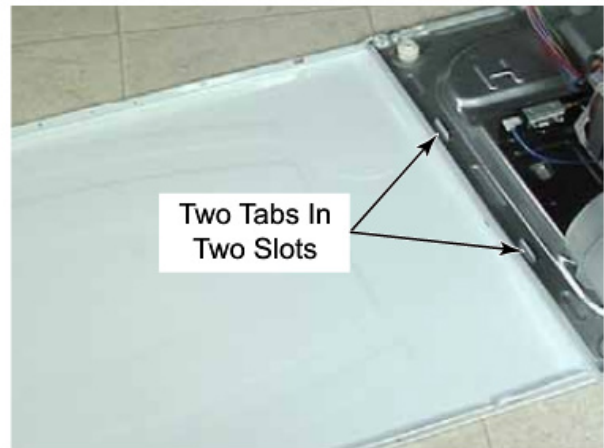

REMOVE REAR BULKHEAD

⚠ WARNING



Electrical Shock Hazard
Disconnect power before servicing.
Replace all parts and panels before operating.
Failure to do so can result in death or electrical shock.

1. Remove dryer drum (See page 4-22).
2. Remove side panels (See page 4-32).
3. Support rear bulkhead when removing side panels.



4. Use a pair of pliers to squeeze two Christmas tree clips to release wire ties holding wiring harness to rear bulkhead.

REMOVE HEAT PLENUM

⚠ WARNING



Electrical Shock Hazard
Disconnect power before servicing.
Replace all parts and panels before operating.
Failure to do so can result in death or electrical shock.

1. Remove rear panel (See page 4-31).
2. Remove two 1/4" hex head screws that secure heat plenum to back of rear bulkhead.



3. Tilt lower edge of heat plenum out away from rear bulkhead to release the tab on the top of the heat duct from inside heat plenum. Pull heat plenum away from rear bulkhead.

REMOVE METERCASE

⚠ WARNING



Electrical Shock Hazard
Disconnect power before servicing.
Replace all parts and panels before operating.
Failure to do so can result in death or electrical shock.



1. Remove coin box.
2. Remove two 1/2" hex head bolts below coin box in the front of the metercase.



3. Remove service access door on top rear of metercase.
4. Remove two 1/2" hex head bolts from inside the service access area at the base of the metercase. (See photo at top of next column)

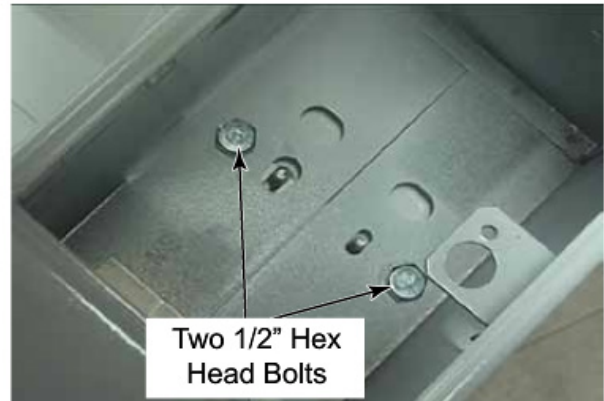

5. Lift metercase off the top of the dryer.

6. Remove metercase pad by lifting it off the top of the dryer.



REMOVE METERCASE MOUNTING BRACKETS

⚠ WARNING



Electrical Shock Hazard
Disconnect power before servicing.
Replace all parts and panels before operating.
Failure to do so can result in death or electrical shock.

1. Remove metercase (See page 4-34).
2. Open top of dryer (See page 4-3).

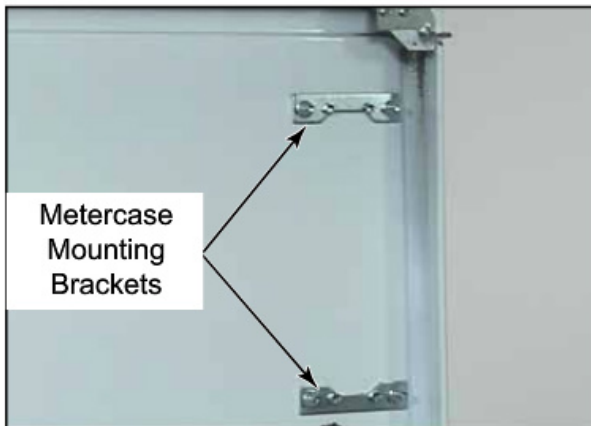

3. Remove two 5/16" hex head screws in each bracket. Remove bracket. These brackets are what the metercase bolts screw into.

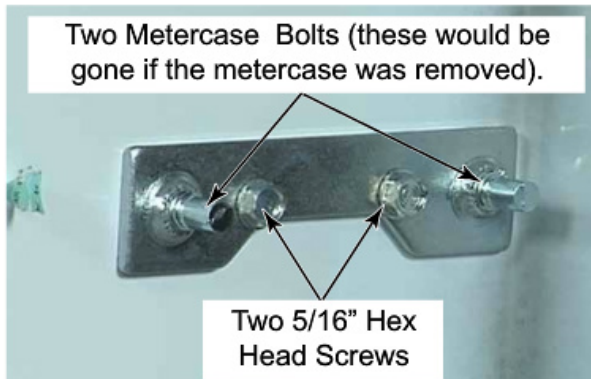

REMOVE SERVICE ACCESS SWITCH - PD MODEL

⚠ WARNING



Electrical Shock Hazard
Disconnect power before servicing.
Replace all parts and panels before operating.
Failure to do so can result in death or electrical shock.

1. Remove the service access door from the top of the metercase.
2. Remove the 5/16" hex head screw to release the bracket that holds the service access switch.



3. Disconnect two wire connectors from the switch terminals.
4. To remove the service access switch from the mounting bracket, press the locking tabs on both ends of the switch and push the switch up out of the mounting bracket.

REMOVE COIN VAULT SWITCH - PD MODEL

⚠ WARNING



Electrical Shock Hazard
Disconnect power before servicing.
Replace all parts and panels before operating.
Failure to do so can result in death or electrical shock.

1. Remove coin box.

 2. Remove service access door from top of metercase.

3. Remove two wire connectors from the switch terminals.

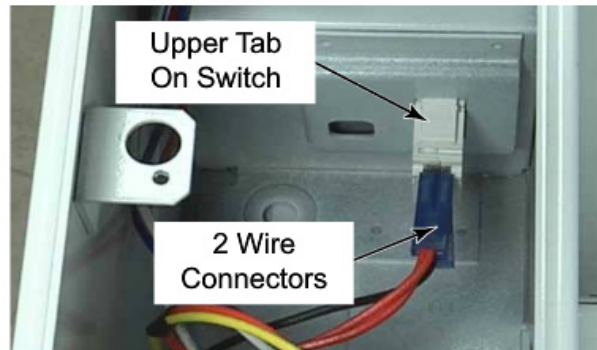

4. Squeeze tabs on top and bottom of switch from inside the service access area and push switch into coin vault compartment.



4-36

REMOVE COIN DROP - PD MODEL

⚠ WARNING

<p>Electrical Shock Hazard Disconnect power before servicing. Replace all parts and panels before operating. Failure to do so can result in death or electrical shock.</p>

NOTE: When reinstalling the coin drop make sure that wires connected to the coin sensor go straight back from the coin sensor. If wire goes forward it could break the beam of the coin sensor and show an error on the UIC.

NOTE: There are 2 female connectors that accept a coin drop harness. The female connector that is black in color or has a black permanent marker scribbled on it is for coin 2 of a dual coin acceptor. When a single coin acceptor is used it should be connected to the coin 1 connector with no mark on it, or that is white in color when the other is black.

1. Remove service access door from top of metercase.

 2. Remove two 1/4" security bolts from inside the service access area.

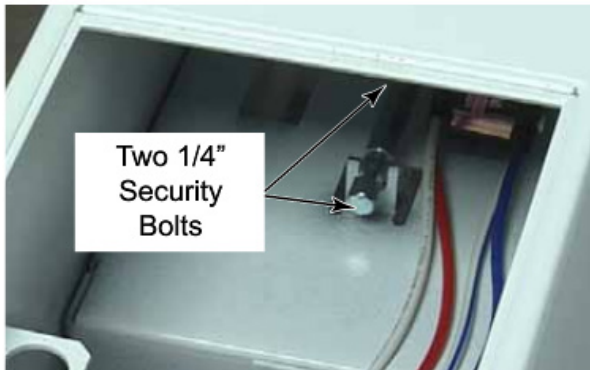

3. Disconnect wire harness connectors from coin sensor switch(es) as necessary.

4. Pull coin drop out from the front of the metercase.



4-37

REMOVE FLAME SENSOR

⚠ WARNING

<p>Electrical Shock Hazard Disconnect power before servicing. Replace all parts and panels before operating. Failure to do so can result in death or electrical shock.</p>

1. Remove service panel (See page 4-16).

 2. Remove the two wire connectors from the spade terminals.

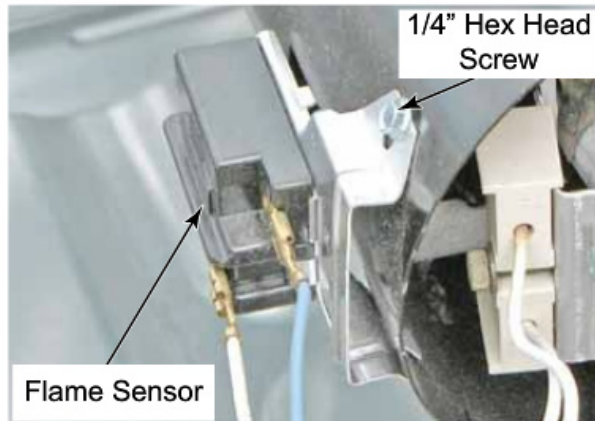
NOTE: The spade connectors are on tight and pulling hard on the wire or connector without care may pull the flame switch male terminal off the control and render flame switch useless.



3. Remove the 1/4" hex head screw.

4. Rotate flame sensor down to release the tab that secures the other side.

REMOVE HIGH TEMP THERMOSTAT

⚠ WARNING

<p>Electrical Shock Hazard Disconnect power before servicing. Replace all parts and panels before operating. Failure to do so can result in death or electrical shock.</p>

1. Remove service panel (See page 4-16).

 2. Remove red and black wire connectors.

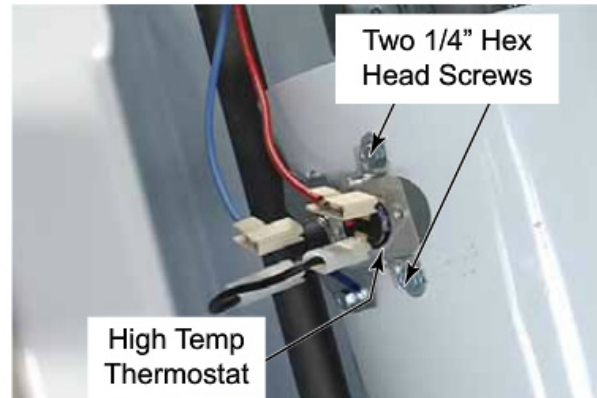
3. Remove two 1/4" hex head screws and remove high temp thermostat.



NOTE: The high temp thermostat and high temp cutout (See page 4-39) should be ordered and replaced as a set. The high temp thermostat is resettable and cycles to keep the temperature from getting too hot in the burner.

REMOVE HIGH TEMP CUTOUT

⚠ WARNING



Electrical Shock Hazard
Disconnect power before servicing.
Replace all parts and panels before operating.
Failure to do so can result in death or electrical shock.

1. Remove service panel (See page 4-16).

 2. Remove the jumper between the high temp thermostat and the high temp cutout.

3. Remove the blue wire connector from the spade terminal.

4. Remove the 1/4" hex head screw and lift to release the tab on the other side.

NOTE: The high temp cutout is not resettable, it will disable the heat if it trips.

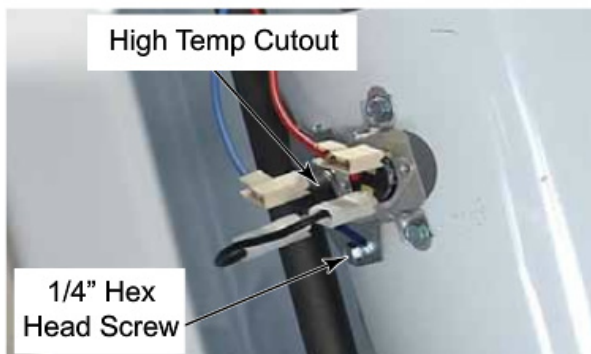

TECH TIP: If the high temp cutout is being replaced, the high temp thermostat should be replaced as well, since the high temp thermostat should have shut the heat off before the dryer reached the temperature at which the high temp cutout would trip.

REMOVE IGNITOR

⚠ WARNING



Electrical Shock Hazard
Disconnect power before servicing.
Replace all parts and panels before operating.
Failure to do so can result in death or electrical shock.

1. Remove service panel (See page 4-16).

 2. Disconnect wire connector to ignitor.

3. Hold bracket and remove the 5/16" hex head screw to remove bracket and ignitor.

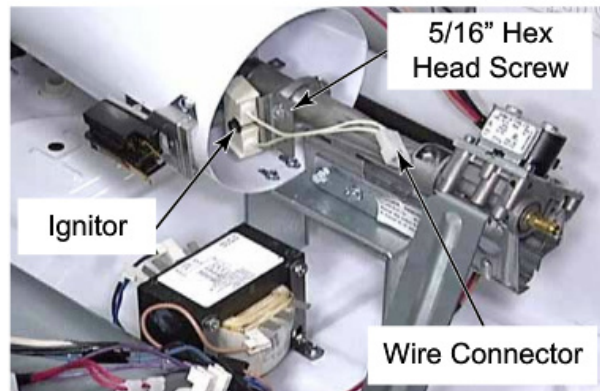

4. Remove ignitor from bracket by removing the 5/16" hex head screw.

NOTE: Do not touch the dark ignitor end, skin oil will make a hot spot on the ignitor causing it to fail prematurely.

NOTE: Take care not to bump or tap the ignitor. It is made of carborundum, which is harder than steel but is extremely brittle.

REMOVE AUTO TRANSFORMER - GAS DRYERS

⚠ WARNING



Electrical Shock Hazard
Disconnect power before servicing.
Replace all parts and panels before operating.
Failure to do so can result in death or electrical shock.

1. Remove service panel (See page 4-16).
-  2. Remove two 1/4" hex head screws that secure the gas valve bracket brace to the base of the dryer
3. Remove the gas valve bracket brace to gain access to the screws for the auto transformer.
4. Remove the three wire connector from the auto transformer.
5. Remove four 1/4" hex head screws that secure each corner of the auto transformer to the base of the dryer. These screws have permanently attached washers.

6. Wire connections on the auto transformer:
 "L1LD" terminal is the blue wire
 "LD" terminal is the black wire
 See page 5-14 for the beige wire.

These three wires are disconnected together from the three wire connector, in the dryer, with Red, Black and Blue wires.

NOTE: There is a schematic for the auto transformer on the base of the dryer.

LD Terminal
Black Wire

L1LD Terminal
Blue Wire

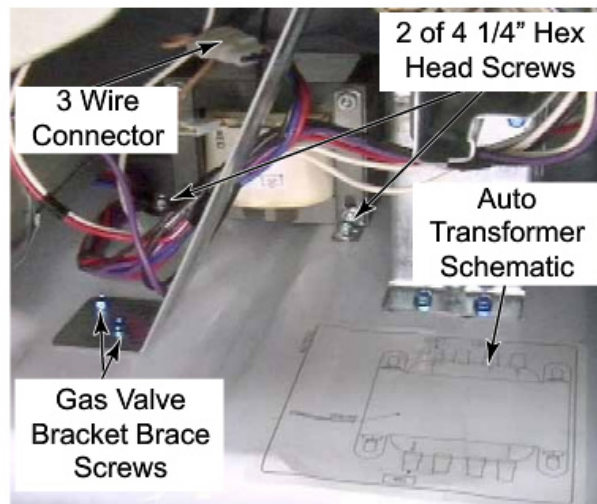
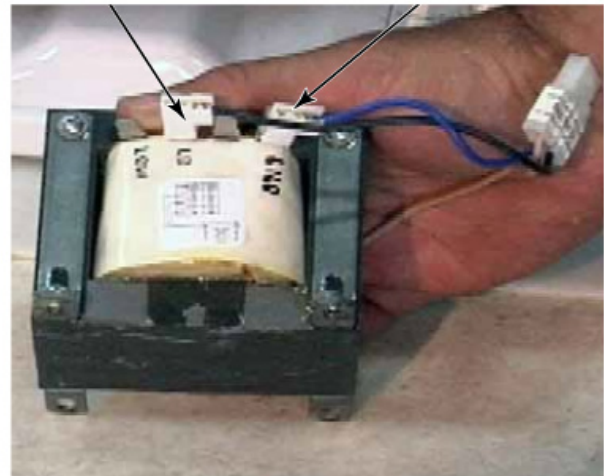

REMOVE GAS VALVE COILS

⚠ WARNING



Electrical Shock Hazard
Disconnect power before servicing.
Replace all parts and panels before operating.
Failure to do so can result in death or electrical shock.

1. Remove service panel (See page 4-16).

 2. Disconnect wire connector from each coil

3. Remove two screws that secure the coil bracket.

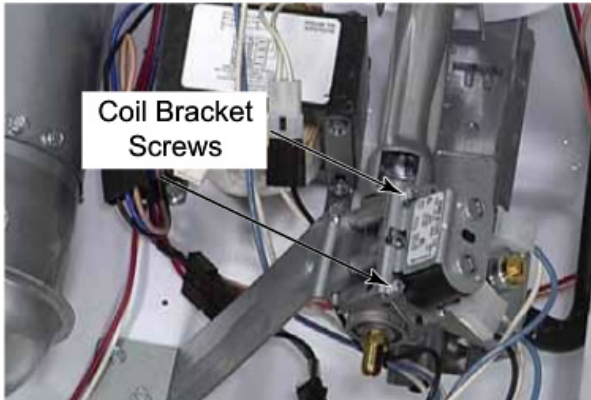

4. Lift bracket off coils.

NOTE: When reinstalling or replacing coils make sure that the positioning pins on the coils are fitted into the matching holes in the coil bracket before tightening the bracket in place. Also make sure that replacement coils are rated for 50Hz.

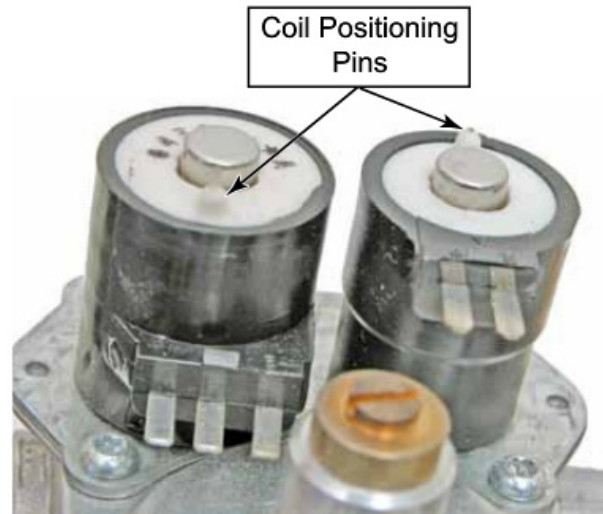

5. Lift coils off posts. There is a sleeve on one post, make sure to save it for reinstallation or replacement of the coils, because new coils do not come with a new sleeve.

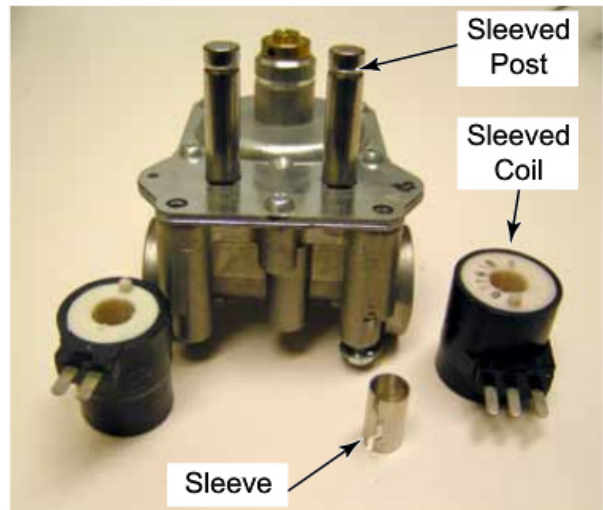

REMOVE GAS VALVE ASSEMBLY

⚠ WARNING



Electrical Shock Hazard
Disconnect power before servicing.
Replace all parts and panels before operating.
Failure to do so can result in death or electrical shock.

1. Shut off the gas supply to the dryer.
2. Disconnect gas line from rear of the dryer.
3. Remove service panel (See page 4-16).

4. Loosen the 1/4" hex head screw that runs left to right through the bracket that secures the gas pipe to the rear panel.



NOTE: It may be necessary to remove the drum in order to locate this 1/4" hex head screw (See page 4-22).

5. Disconnect the wires to the ignitor, and the valve coils.

6. Remove two 1/4" hex head screws that secure the brace to base of the dryer and twist to remove the brace from under the gas valve.

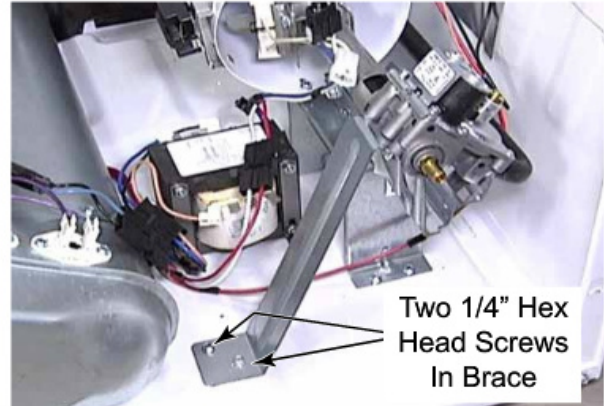

7. Remove two 1/4" hex head screws that secure the gas valve bracket to the burner assembly.

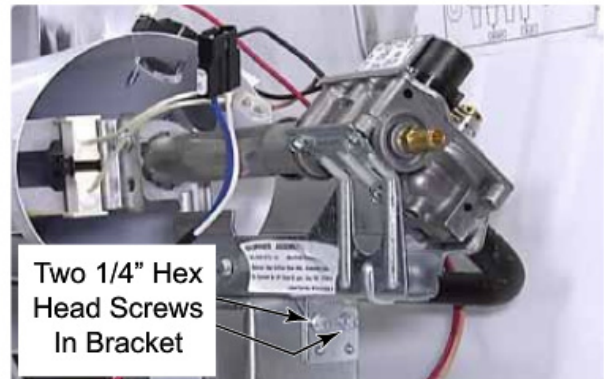

8. Slide the gas valve along with the ignitor and the gas pipe out off the dryer.

NOTE: It is recommended that the ignitor be removed prior to removal of the gas valve assembly to avoid damage to the ignitor.

REMOVE GAS VALVE FROM BRACKET

⚠ WARNING

<p style="text-align: center;">Electrical Shock Hazard</p> <p style="text-align: center;">Disconnect power before servicing.</p> <p style="text-align: center;">Replace all parts and panels before operating.</p> <p style="text-align: center;">Failure to do so can result in death or electrical shock.</p>

1. Remove service panel (See page 4-16).

2. Remove gas valve assembly (See page 4-42).

 3. Secure the gas valve and turn the gas pipe in a counter-clockwise direction to remove the gas pipe from the gas valve.



NOTE: Use an appropriate sealant (rated for natural gas or LP depending on fuel type) during reassembly of this gas pipe.

4. Remove three 1/4" hex head screws from bottom of bracket.

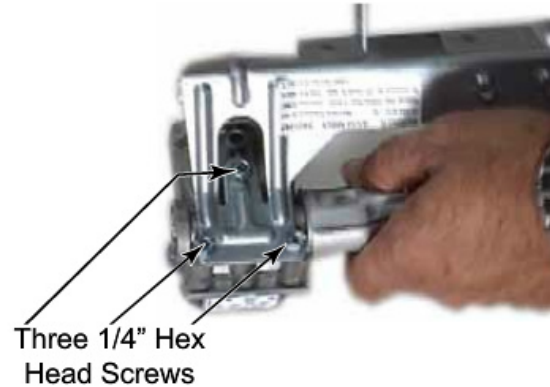

5. Remove gas valve body from bracket.

6. Gas valve orifice is now accessible and can be removed with a 3/8" wrench.

NOTE: Make sure not to use sealant on threads of the gas valve orifice.

TECH TIP: When replacing a gas valve assembly it is always prudent to remove the orifice from the original gas valve and install it on the new valve. This helps avoid having the wrong size orifice on the dryer after a gas valve replacement.

NOTE: All replacement gas valves for this dryer come set for natural gas use. When working on a dryer that uses LP gas, the valve will need to be reconfigured. See instructions with the LP kit.

REMOVE ELECTRIC HEATING ELEMENT

⚠ WARNING



Electrical Shock Hazard
Disconnect power before servicing.
Replace all parts and panels before operating.
Failure to do so can result in death or electrical shock.

1. Remove service panel (See page 4-16).

 2. Remove 6 wire connectors from high temp thermostat, high temp cutout and heater coil.



3. Remove the 1/4" hex head screw that secures bracket to bottom of dryer.



4. Lift bracket and heater assembly to remove the bottom edge of the assembly and press down to release the tab from inside the heat plenum at the back of the dryer.



5. Remove assembly from the dryer.



REMOVE HEATER COIL

⚠ WARNING

<p>Electrical Shock Hazard Disconnect power before servicing. Replace all parts and panels before operating. Failure to do so can result in death or electrical shock.</p>

1. To service the element, remove electric heat assembly (See page 4-44).

 2. Remove two 1/4" hex head screws from the bottom and side of housing.



3. Slide mounting bracket tab out of slot in the housing and remove it.

4. Use a pair of pliers to hold the housing and another pair of pliers to pull heater coil up out of the housing.

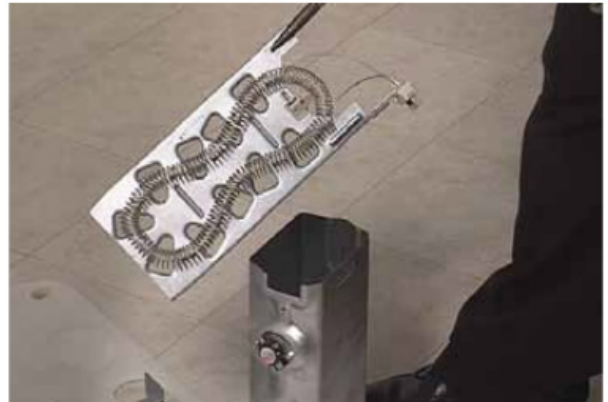

REMOVE 180° OPENING DOOR AND HINGE

1. The door on the Model 25 dryer swings completely open (180°).
2. This 180° hinge required that the door trim parts be modified. Therefore the 180° hinge is not backwards compatible to the Model 22 dryer doors.
3. The 180° opening door services and comes apart in the same manner as the Model 22 door does.

 4. Open dryer door.

5. Loosen but do not remove the second screw down from the top of the door hinge.

NOTE: The hole for this screw is snowman shaped which will allow the screw to pass through it when lifting door off dryer.

6. Remove the remaining three star head screws that secure the door hinge to the dryer front panel.



NOTE: These screws are tapered and serrated like the hinge screws for the dryer top, but they are larger than those for the top hinges. Serrated head helps keep screws tight without a lock washer.

7. After removing three and loosening one screw, grasp the door and pull the hook of the hinge out of the slot in front panel, then lift door hinge off the remaining screw.



REMOVE CONTROL PANEL COVER AND SNAP-IN DISPLAY LENS

⚠ WARNING



Electrical Shock Hazard
Disconnect power before servicing.
Replace all parts and panels before operating.
Failure to do so can result in death or electrical shock.

1. Model 25 dryers use a snap-in display lens. This snap-in style lens requires that the control panel cover be removed in order to release the tabs that lock the display lens in place over the fascia. A snap-in display lens can be used as a replacement part for both the Model 25 and the Model 22 commercial dryers.

2. Remove the four T-20 security machine screws from the front of the fascia.



NOTE: To avoid damage, lay a towel, or another covering, on the dryer top and place removed hardware and tools on the covering.

3. Remove four T-20 security machine screws from the name plate. Support the name plate when removing the final screw.



4. Pull control panel cover away from front of dryer.



5. Depress the clips on the edges of the display lens on the back side of the control panel cover. Remove the display lens from the front of the cover.

— NOTES —

COMPONENT TESTING

	⚠ WARNING
	<p>Electrical Shock Hazard</p> <p>Disconnect power before servicing.</p> <p>Replace all parts and panels before operating.</p> <p>Failure to do so can result in death or electrical shock.</p>

GAS VALVE COILS

The gas valve is actually a regulator and 2 valves in 1. Each valve is in series with the other.

The first valve has a split coil and requires both coils to lift the armature, but only 1 coil to hold it open. It is this split coil with 3 terminals that has the metal sleeve between it and the valve post. The second or secondary coil has only 1 coil.

1. Unplug dryer or disconnect power.
2. Turn off gas supply to dryer.
3. Remove gas valve coils [\(See page 4-41\)](#).
4. Disconnect the wire connectors from the coil terminals.
5. Set the ohmmeter to the R X 100 scale.
Set digital ohmmeters to lowest scale.

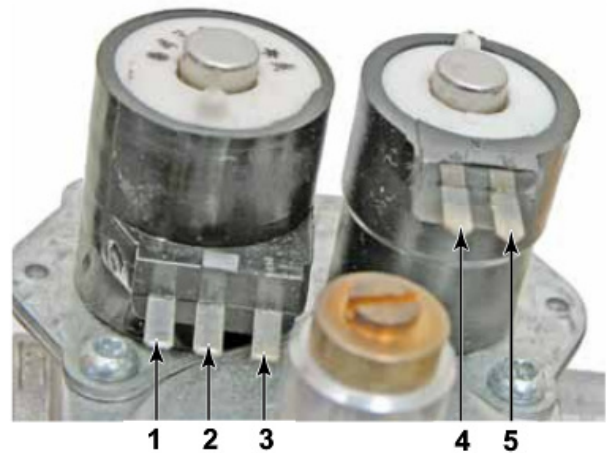

6. Touch the ohmmeter test leads to the indicated coil terminals. The meter should indicate as follows:

Pins 1 & 2 = 1760Ω

Pins 1 & 3 = 720Ω

Pins 4 & 5 = 1740Ω

All readings ± 5%

NOTE: Black and oily soot on the interior drum and bulkhead surfaces probably indicates that the regulator is not set-up for the proper gas type.

	⚠ WARNING
	<p>Electrical Shock Hazard</p> <p>Disconnect power before servicing.</p> <p>Replace all parts and panels before operating.</p> <p>Failure to do so can result in death or electrical shock.</p>

BURNER IGNITOR

When the dryer control calls for heat, line voltage is applied to the ignitor. The ignitor will heat up quickly and glow as it reaches approximately 1200°C (2200°F) in about 30 seconds. Gas contacting the ignitor at this temperature will ignite immediately.

1. Unplug dryer or disconnect power.
2. Turn off gas supply to dryer.
3. Remove gas burner ignitor
(See page 4-39).
4. Disconnect ignitor wire connectors from the main harness connector.
5. Set the ohmmeter to the R X 1 scale.
Set digital ohmmeter to lowest scale.
6. Touch ohmmeter test leads to the 2-wire connector pins. The meter should indicate between 50 and 250Ω at room temperature.

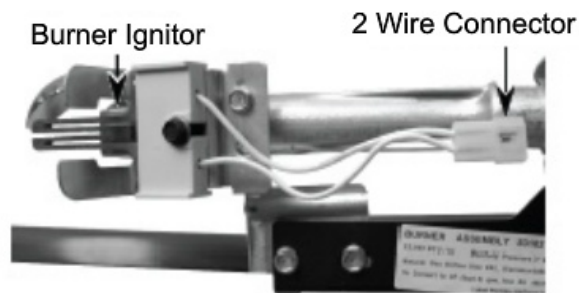

MANOMETERS

Insufficient gas flow can cause problems. Therefore, checking the gas pressure at the time service calls are performed may avoid a return call.

Gas pressure can be checked with an instrument called a "manometer." This device can detect a "low" LP tank, restricted gas flow, bad gas valve, a malfunctioning pressure regulator, too many gas appliances operating off of a small supply line, or an improperly converted appliance from Natural to LP gas.

Other types of manometers exist; however, the type of manometer we will discuss in this manual is a water tube with a glass tube inserted into it. Water is added to the outer tube and it rises within the inner tube to equalize and seek its own level, the same method is used in both arms of a "U" shaped tube Manometer.

A flexible rubber hose is connected to the upper, open end of the manometer and to the gas source. Gas pressure is exerted on one of the water columns, pushing it down. The water level then rises in the other column. The pressure is then read on the manometer as the water column pushes downward.

The water column (W.C.) for a Maytag dryer is 3.5" W.C. for Natural gas and 11" W.C. for LP gas.

	⚠ WARNING
	<p>Electrical Shock Hazard</p> <p>Disconnect power before servicing.</p> <p>Replace all parts and panels before operating.</p> <p>Failure to do so can result in death or electrical shock.</p>

How to use a manometer:

1. Disconnect power supply to dryer.
2. Remove front panel.
3. Shut off gas to dryer.
4. If not already present, install a 1/4" tapered fitting at the gas valve pressure tap. Use thread seal tape or compound on fitting.



5. Fill the manometer tube with water until each side equalizes at "0" water column.
6. Using a narrow #1 or pocket type flat blade screwdriver, turn the slotted adjustment screw, inside the 1/4" tapered fitting, counter-clockwise about 1 full turn. Push the end of the manometer hose onto the pressure tap.
7. Connect hose to one end of the manometer.

8. Turn on the gas and reconnect dryer to power. Run the dryer in a heat cycle. Read the manometer with the flame on.
9. When the gas is on, the amount of water column present is equal to the total amount of deflection shown in the manometer.

Once the test is completed, make sure the tapered fitting valve is closed by turning the slotted adjustment screw clockwise until tight.

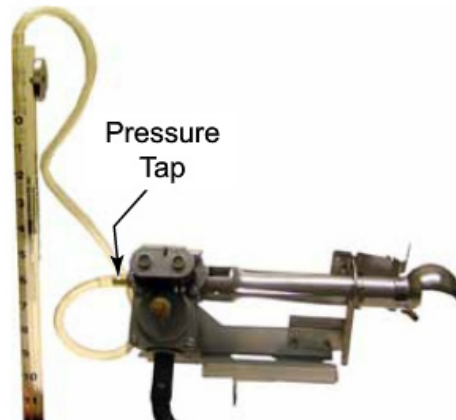

Check for gas leaks with a soap or bubble solution. **DO NOT USE OPEN FLAME TO CHECK FOR GAS LEAKS.**

IF HIGH WATER COLUMN PRESSURE IS DETECTED: The gas flame can damage the flame spreader on the burner. (This can be caused by the wrong orifice, improper air mixture or high gas pressure. If pressure is higher than expected, contact local gas utilities company to check outside regulator.

	⚠ WARNING
	<p>Electrical Shock Hazard</p> <p>Disconnect power before servicing.</p> <p>Replace all parts and panels before operating.</p> <p>Failure to do so can result in death or electrical shock.</p>

FLAME SENSOR

1. Unplug dryer or disconnect power.
2. Turn off gas supply to dryer.
3. Access the flame sensor [\(See page 4-38\)](#).
4. Disconnect the wire connectors from the flame sensor terminals.
5. Set the ohmmeter to the R X 1 scale. Set digital ohmmeters to lowest scale.
6. Touch the ohmmeter test leads to the flame sensor terminals. The meter should indicate a closed circuit (0Ω) when cold.

NOTE: If the ignitor stays on longer than 40 seconds, replace the Radiant Sensor.

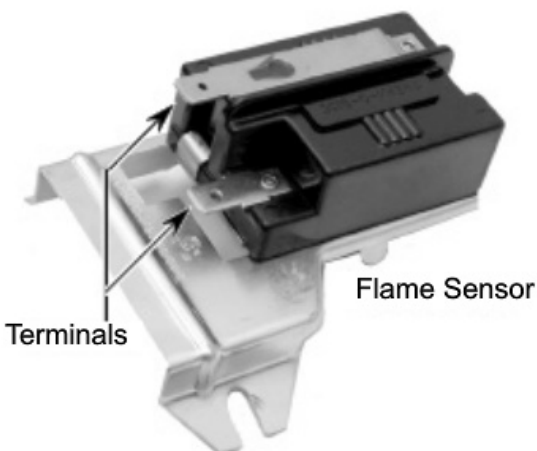

HIGH TEMP THERMOSTAT & HIGH TEMP CUTOUT (GAS DRYERS)

The High Temp Thermostat cycles open at temperatures above 121°C (250°F). The high temp cutout is a non-resettable device. The cutout temperature is 178°C (352°F).

1. Unplug dryer or disconnect power.
2. Turn off gas supply to dryer.
3. Remove high temp thermostat [\(See page 4-38\)](#) or high temp cutout [\(See page 4-39\)](#).
4. Disconnect wire connectors from high temp thermostat and high temp cutout terminals.
5. Set the ohmmeter to the R X 1 scale. Set digital ohmmeters to lowest scale.
6. Touch ohmmeter test leads to the high temp thermostat or high temp cutout terminals. Meter should indicate a closed circuit (0Ω).

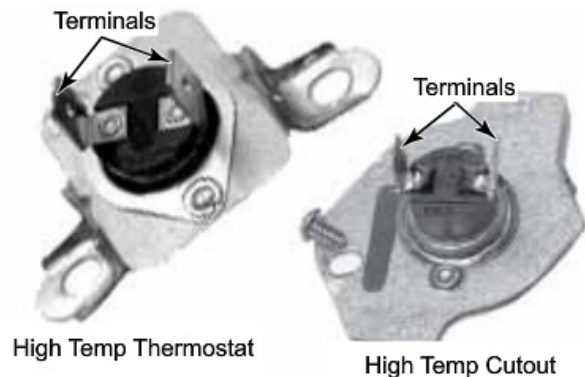

	⚠ WARNING
	Electrical Shock Hazard Disconnect power before servicing. Replace all parts and panels before operating. Failure to do so can result in death or electrical shock.

HEATING ELEMENT (ELECTRIC DRYERS)

1. Unplug dryer or disconnect power.
2. Remove the electric heating element.
(See page 4-44).
3. Disconnect the wire connectors from the heater terminal block
4. Set the ohmmeter to the R X 1 scale.
Set digital ohmmeters to lowest scale.
5. Touch the ohmmeter test leads to the terminals on the heater terminal block. The meter should indicate between 11 and 16 Ω .
6. Touch an ohmmeter test lead to an element terminal block connection, and the other test lead to the heater housing case. Reading should be an open circuit (infinite Ω). A resistance reading indicates a shorted coil.

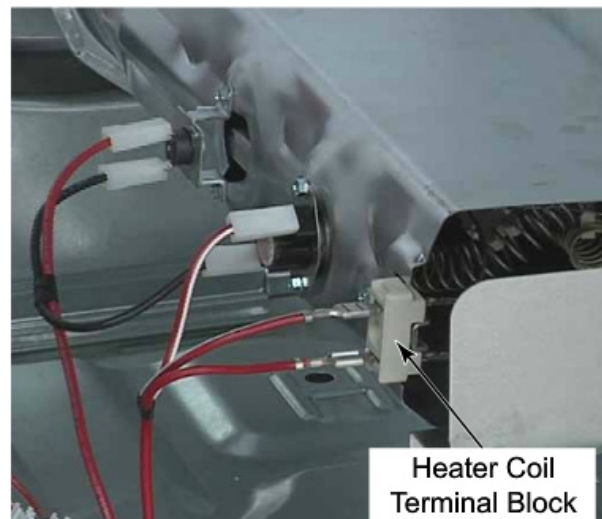

The heater element on electric dryers is designed to provide 4600 watts when operated on 240 volts.

	⚠ WARNING
	<p>Electrical Shock Hazard</p> <p>Disconnect power before servicing.</p> <p>Replace all parts and panels before operating.</p> <p>Failure to do so can result in death or electrical shock.</p>

HIGH TEMP CUTOUT (ELECTRIC DRYERS)

Access the Electric Heating Element
(See page 4-44).

The high temp cutout is a non resettable device. The cutout temperature is 178°C (352°F).

If the dryer does not heat and there is 240VAC to the dryer, perform the following test.

1. Unplug dryer or disconnect power.
2. Disconnect the wires from the high temp cutout.
3. Set the ohmmeter to the R X 1 scale.
Set digital ohmmeters to lowest scale.
4. Touch the ohmmeter test leads to the high temp cutout terminals. The meter should indicate continuity (0Ω). If the meter indicates an open circuit (infinite Ω), replace both the high temp cutout and the high temp thermostat. In addition, check for a failed heater element, or a blocked, or improper exhaust system.

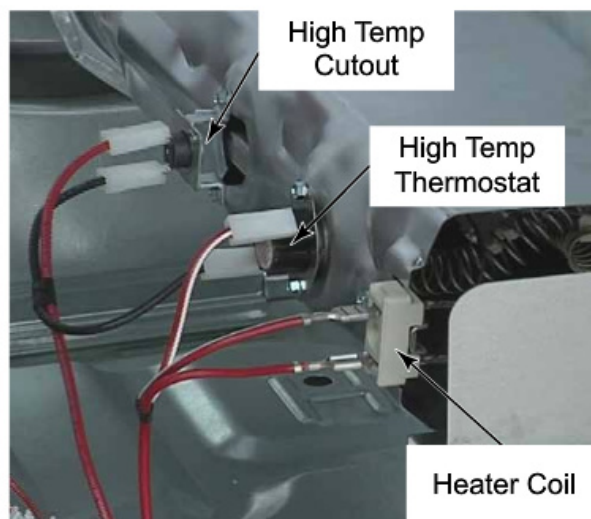

NOTE: Dryers that have poor ventilation, and exhibit higher than normal venting back-pressure, can begin cycling the heater with the High Temp Thermostat rather than the Operating Thermistor. When this occurs poor drying or long dry times are usually the result.



	⚠ WARNING
	<p>Electrical Shock Hazard</p> <p>Disconnect power before servicing.</p> <p>Replace all parts and panels before operating.</p> <p>Failure to do so can result in death or electrical shock.</p>

CENTRIFUGAL SWITCH

1. Unplug dryer or disconnect power.
2. Turn off gas supply to dryer.
3. Pull individual wire connectors from motor centrifugal switch as needed for testing.
4. Set ohmmeter to the R X 1 scale.
Set digital ohmmeters to lowest scale.
5. Touch one meter test lead to pin 5 of the centrifugal switch and the other test lead to pin 3. The meter should indicate Continuity (3 - 4Ω).
6. Depress the brown disc located behind the motor switch on the motor shaft. The meter should indicate an open circuit (infinite Ω).

NOTE: The brown disc actuates the lever of the motor switch when the motor is at rest. At optimum motor speed, the disc moves away from the switch lever. When the disc is pressed in toward the windings, the actuator arm of the centrifugal switch will be relaxed. This allows the contacts to close, completing the heater circuit.

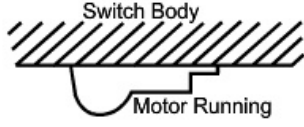
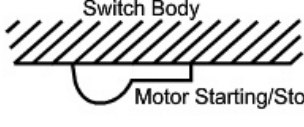
7. Test the other contacts of the centrifugal switch following the chart below.

Actuator Position	Switch Position		
	5-3	5-6	1-2
 <p style="text-align: center;">Motor Running</p>	O	X	X
 <p style="text-align: center;">Motor Starting/Stopping</p>	O	X	X
 <p style="text-align: center;">Motor Off</p>	X	O	O

O = Open
X = Closed

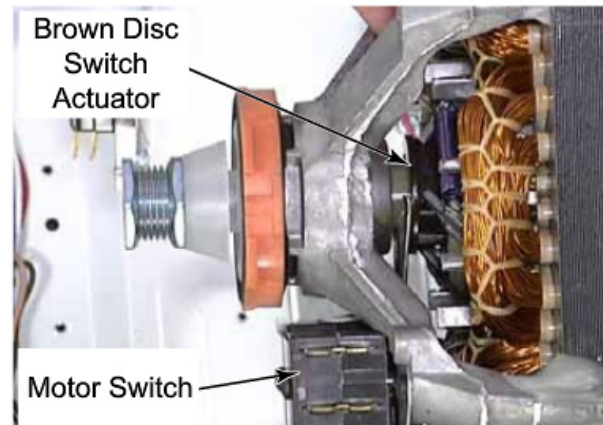

8. If any test fails, replace the centrifugal switch.

	⚠ WARNING
	<p>Electrical Shock Hazard</p> <p>Disconnect power before servicing.</p> <p>Replace all parts and panels before operating.</p> <p>Failure to do so can result in death or electrical shock.</p>

DRIVE MOTOR

1. Unplug dryer or disconnect power.
2. Turn off gas supply to dryer.
3. Remove the three wires from the motor connected to the centrifugal switch.
4. Set ohmmeter to the R X 1 scale.
Set digital ohmmeters to lowest scale.
5. Run winding test: Touch one ohmmeter test lead to the white wire connector, and the other test lead to the blue wire connector. The meter should indicate $12.6\Omega (\pm 2\Omega)$ (run winding).
6. Start winding test: Touch one ohmmeter test lead to the violet wire connector, and the other test lead to white wire connector. The meter should indicate $12.6\Omega (\pm 2\Omega)$

If the resistances at the motor are correct, check for a failed or broken belt switch. Touch the ohmmeter test lead to the broken belt switch terminals. Lift the idler arm assembly. The meter should indicate continuity (0Ω).

If The meter should indicate an open circuit (infinite Ω), replace the broken belt switch.



	⚠ WARNING
	<p>Electrical Shock Hazard</p> <p>Disconnect power before servicing.</p> <p>Replace all parts and panels before operating.</p> <p>Failure to do so can result in death or electrical shock.</p>

THERMISTOR

1. Check the thermistor resistance value at any or all of the temperature levels in question, using the Dry Cycle, and the following process:

Hold a glass bulb thermometer capable of reading from 32° to 82°C (90° to 180°F) in the center of the exhaust outlet. The correct exhaust temperatures are as follows:

EXHAUST TEMPERATURES		
FABRIC SETTING	HEAT TURNS OFF*	HEAT TURNS ON
Whites And Colors	155° ± 5°F (68° ± 3°C)	10-15°F (6-8°C) Below the heat turn off temperature
Perm. Press	155° ± 5°F (68° ± 3°C)	
Delicates	140° ± 5°F (60° ± 3°C)	

* The measured overshoot using the glass bulb thermometer in the exhaust outlet can be 17 °C (30 °F) higher.

2. If the exhaust temperature is not within specified limits, unplug dryer or disconnect power.
3. Check the resistance of the thermistor.

NOTE: Thermistor resistance measurements must be made while dryer is disconnected from power and at least 1 lead removed from the thermistor..

The table below gives the resistance values that should be observed for the various temperature settings.

FABRIC SETTING	TEMPERATURE	Thermistor resistance value at heater shutoff (digital or analog meter) kΩ
Whites and Colors	155° ± 5°F (68° ± 3°C)	2.1 - 1.7
Perm. Press	155° ± 5°F (68° ± 3°C)	2.1 - 1.7
Delicates	140° ± 5°F (60° ± 3°C)	2.8 - 2.3

If needed, the following table gives temperatures and their associated resistance values.

THERMISTOR RESISTANCE			
TEMP. °F (°C)	RES. kΩ	TEMP. °F (°C)	RES. kΩ
50° (10°)	19.9	80° (27°)	9.2
60° (16°)	15.3	90° (32°)	7.4
70° (21°)	11.9	100° (38°)	5.7

- If the thermistor resistance checks within normal limit, replace dryer CCU control.

	⚠ WARNING
	<p>Electrical Shock Hazard</p> <p>Disconnect power before servicing.</p> <p>Replace all parts and panels before operating.</p> <p>Failure to do so can result in death or electrical shock.</p>

THERMAL FUSE

1. Unplug dryer or disconnect power.
2. Turn off gas supply to dryer.
3. Disconnect wires from thermal fuse.
4. Remove thermal fuse (See page 4-24).
5. Set the ohmmeter to the R X 1 scale.
Set digital ohmmeters to lowest scale.
6. Touch the ohmmeter test leads to the thermal fuse terminals. The meter should indicate continuity (0Ω). If the meter indicates an open circuit (infinite Ω), replace the thermal fuse.

The thermal fuse is wired in series with the drive motor. If the thermal fuse opens, $91^{\circ}\text{C} \pm 6^{\circ}\text{C}$ (196°F), power to the motor is turned off. The centrifugal switch on the motor opens the gas valve coil circuit or electric element circuit.

Once the thermal fuse has opened, it will not reset, and must be replaced. Check for a failed thermistor, a shorted heater element or blocked exhaust.

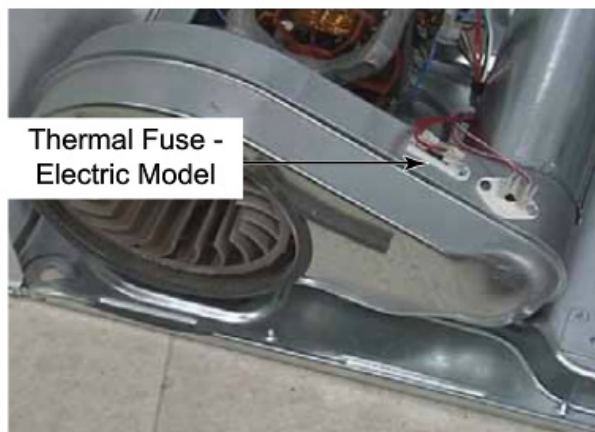

	⚠ WARNING
	<p>Electrical Shock Hazard</p> <p>Disconnect power before servicing.</p> <p>Replace all parts and panels before operating.</p> <p>Failure to do so can result in death or electrical shock.</p>

USER INTERFACE MEMBRANE SWITCH

1. Unplug dryer or disconnect power.
2. Turn off gas supply to dryer.
3. Remove user interface membrane switch
(See page 4-5).
4. Set the ohmmeter to the R X 1 scale.
Set digital ohmmeters to lowest scale.
5. Touch the ohmmeter test leads to the contacts listed. Press the button listed for each pair of contacts. The meter should indicate continuity (0Ω). If the meter indicates an open circuit (infinite Ω), replace the membrane switch.

NOTE: Only the lower row of membrane pads (A, B & C) are used on this model dryer.

3 button user interface membrane switch

Contact	Contact	Button
4	5	A
2	5	B
3	5	C
4	1	D
2	1	E
3	1	F

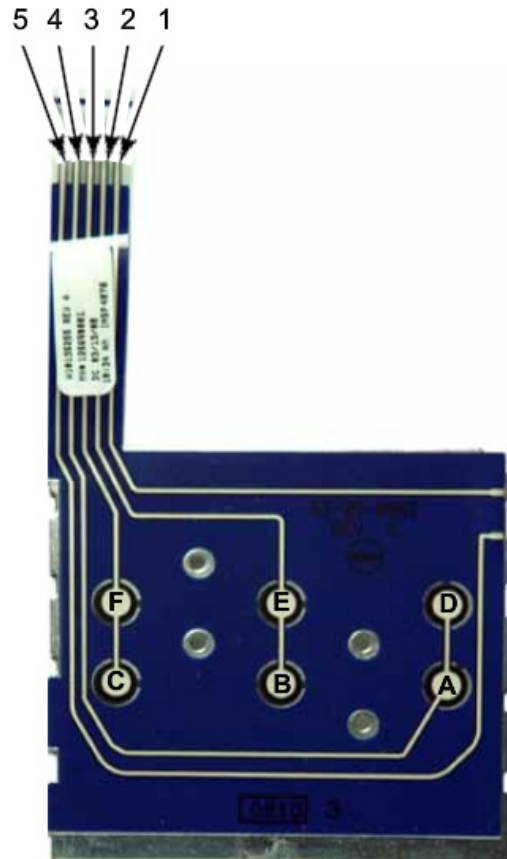

5-11

⚠ WARNING

Electrical Shock Hazard

Disconnect power before servicing.

Replace all parts and panels before operating.

Failure to do so can result in death or electrical shock.



UIC TRANSFORMER

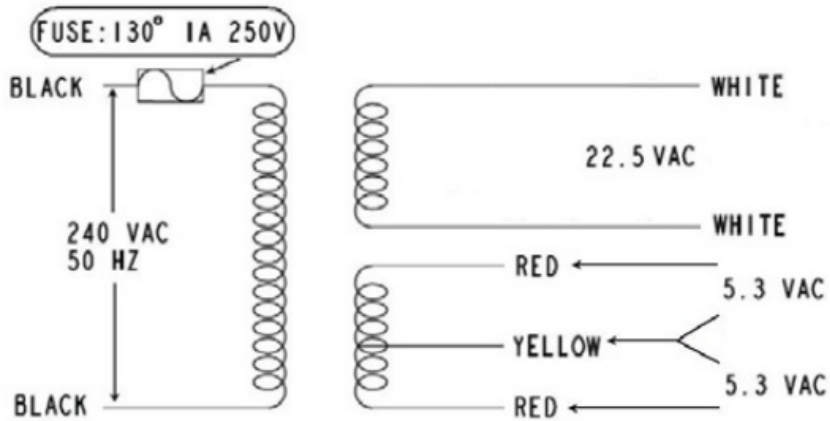

1. Unplug dryer or disconnect power.
2. Turn off gas supply to dryer.
3. Remove transformer (See page 4-8).

Yellow to Red = .8Ω
 Red to Red = 1.2Ω
 White to White = 2.4Ω

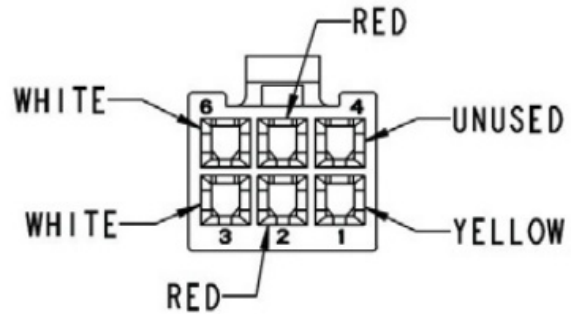
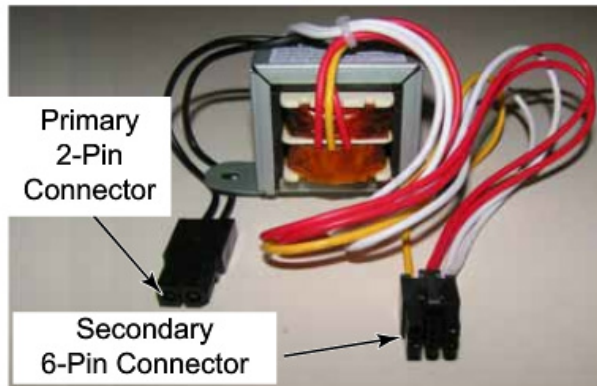

6. Touch the meter test leads to the following terminals in transformer primary 2-pin connector.

Black to Black = 29Ω.

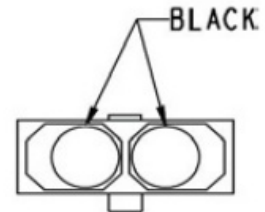

4. Set the ohmmeter to the R X 1 scale. Set digital ohmmeters to lowest scale.
5. Touch meter test leads to terminals in transformer secondary 6-pin connector (shown in next column).

	⚠ WARNING
	<p>Electrical Shock Hazard</p> <p>Disconnect power before servicing. Replace all parts and panels before operating. Failure to do so can result in death or electrical shock.</p>

STEP-DOWN TRANSFORMER - MODEL 22 DRYERS

Model 22 dryers will have a 220VAC to 120VAC step-down transformer on the CCU bracket to provide proper power to the CCU.

1. Unplug dryer or disconnect power.
2. Turn off gas supply to dryer.
3. Remove the step-down transformer
(See page 4-8).

4. Set ohmmeter to the R X 1 scale.
Set digital ohmmeters to lowest scale.
5. Touch the meter test leads to the terminals listed below:
 - Pins GY2 & BK3 = 27 Ω
 - Pins GY2 & WH1 = 45 Ω
 - Pins BK3 & WH1 = 74 Ω
 - All readings \pm 5%



NOTE: Model 25 dryers do not have a step-down transformer, which makes the CCU not backwards compatible from model 25 to model 22

⚠ WARNING

Electrical Shock Hazard

Disconnect power before servicing.

Replace all parts and panels before operating.

Failure to do so can result in death or electrical shock.

AUTO TRANSFORMER - GAS DRYERS

The autotransformer is used in a gas dryer to step down the incoming voltage source to 120VAC used by the gas valve circuit and the control board.

1. Unplug dryer or disconnect power.
2. Turn off gas supply to dryer.
3. See page 4-40 for the procedure to access the auto transformer
4. Connect load to terminals LD & LD.
5. Connect one side of line to L1 terminal.
6. Connect other side of line to terminal selected from table below.

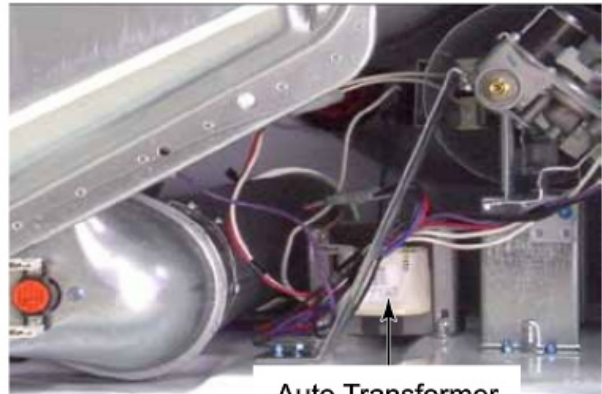
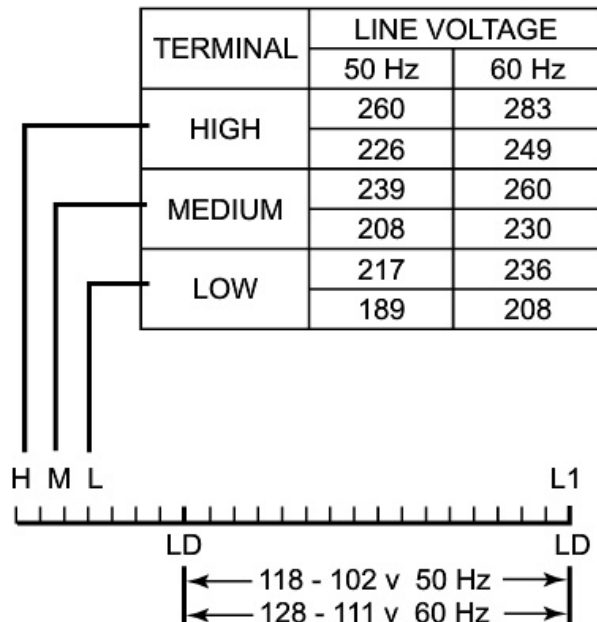

Reconnect power to the dryer and test for proper voltages according to the chart (See left column).

NOTE: There is a proportional relationship between the amount of voltage going in to the transformer and the amount of voltage coming out of the transformer. Higher voltage in should result in higher voltage out.

	⚠ WARNING
	<p>Electrical Shock Hazard</p> <p>Disconnect power before servicing.</p> <p>Replace all parts and panels before operating.</p> <p>Failure to do so can result in death or electrical shock.</p>

COIN DROP ACCEPTOR

The coin drop acceptor is used only in the PD model dryers. This is a mechanical coin drop assembly with a coin sensor attached. In normal use, occasional cleaning in hot water is all that is needed to maintain reliable operation of the coin drop acceptor. The coin drop does not need to be oiled, as it will only cause dirt and dust to collect or build up. This can disrupt the operation of the acceptor.

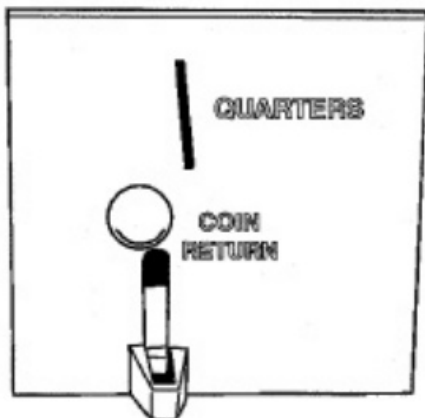

The coin drop assembly checks the diameter, thickness and magnetic properties of the coin.

There is a coin return button that can be pressed if the coin jams in the coin acceptor. When it is pressed, the button presses against a tab which is pushed to one side spreading the coin acceptor plates apart. This allows the coin to fall and roll into the coin return bail area. The face plate has a coin bail (arched area for the coin) which is located at the base of the coin return slot. The face plate can be removed from the coin acceptor by removing two screws from back side of the face plate.

The coin sensor is mounted to a bar located at the back of the coin acceptor. There is a specific time period for a coin to pass the coin sensor. If the coin fails to pass through at a certain speed, the microprocessor may assume the dryer is being tampered with or it is a non-valid coin. The dryer will then go into a standby mode and will not accept coins. The coin sensor is set in position at the time of manufacturing for the proper reading of coins.

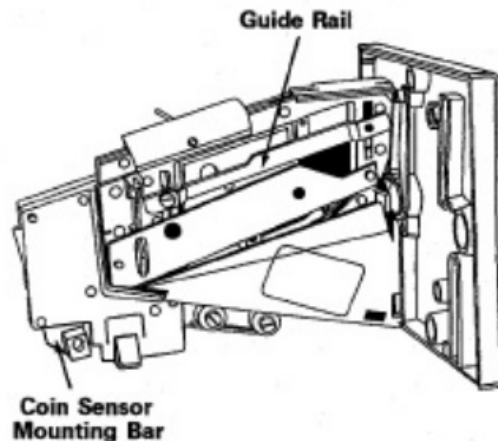

A guide rail on the left plate of the coin drop assembly is adjustable (both at the front and rear) to accept proper diameter coins, yet reject oversized coins. Adjust the front and rear pins in the guide rail to just miss the quarter and tighten the front guide rail screws.

— NOTES —

DIAGNOSIS & TROUBLESHOOTING

PROPER EARTHING OF 240 VOLT WALL OUTLETS

All dryers that plug into a wall outlet have a power cord supplied for the proper configuration. All dryers must be plugged into an earthed outlet.

DIAGNOSTIC CODES

If the set-up mode is entered and one of the following has previously occurred, the appropriate diagnostic code will be in the display.

Models 22 and 25.

ACCU TRAC® INDICATION/ INDICATION ACCU TRAC®	DRYER DISPLAY/ AFFICHAGE DE LA SÉCHEUSE	EXPLANATION
d5	d5	Blocked coin 1 or coin drop UI control circuit failure
d9	d9	Voltage detected below 90 VAC for 8 seconds.
d13	d13	Blocked coin 2 or coin drop UI control circuit failure
d16	d16	Not receiving communications from installed debit card reader in Enhanced (Connection 2) Unit mode.
d4	F-01	Dryer motor control circuit error. The control doesn't know if the motor relay is bad (stuck on), the motor relay drive circuit is bad (stuck off), causing the motor relay to stay on, or the motor relay feedback circuit is bad.
d2	F-22	Exhaust fan motor open, temperature drops below 18°F (>50 hz) for 1 minute in Run mode, or immediately in Factory Diagnostic Mode.
d3	F-23	Exhaust fan motor shorted, temperature above 262°F (<50 hz) for 1 minute in Run mode, or immediately in Factory Diagnostic Mode.
d22	F-70	UI is not receiving communications from CPU
d23	F-71	CPU is not receiving communications from UI
d8	F-73	UI Microprocessor is not able to read or verify EEPROM
d8	F-74	UI EEPROM memory is a CRC failure

TROUBLESHOOTING GUIDE

	<h3 style="margin: 0;">⚠ WARNING</h3>
<p>Electrical Shock Hazard</p> <p>Disconnect power before servicing.</p> <p>Replace all parts and panels before operating.</p> <p>Failure to do so can result in death or electrical shock.</p>	

PROBLEM	POSSIBLE CAUSE / TEST
<p>NOTE: Possible Cause/Tests MUST be performed in the sequence shown for each problem.</p>	
WON'T POWER UP. (No display)	<ol style="list-style-type: none"> 1. Supply connections. See TEST #1. 2. Check harness connections. 3. Console electronics and housing assembly. See TEST #5. 4. Check for loose connections at Transformer.
WON'T START CYCLE WHEN CYCLE BUTTON IS PRESSED.	<ol style="list-style-type: none"> 1. If Select Cycle is flashing, make sure the door is completely shut, and press and hold down a Cycle button for about 1 second. 2. See TEST #2. 3. See TEST #6.
WON'T SHUT OFF WHEN EXPECTED.	<ol style="list-style-type: none"> 1. PD Model: Console electronics and housing assembly. See TEST #5. 2. CS Models: Timer cam not pressed on to timer body tight, missing timer cam lug, excess cycles accumulated on timer, timer motor or gear box stuck or broken timer. 3. MN Models: Timer stuck or damaged.
CONTROL WON'T ACCEPT SELECTIONS.	<p>Keypad Assembly. See TEST #5.</p>
WON'T HEAT.	<ol style="list-style-type: none"> 1. Heater. See TEST #3. 2. Check harness connections. 3. Check installation.

TROUBLESHOOTING TESTS

⚠ WARNING



Electrical Shock Hazard

Disconnect power before servicing.

Replace all parts and panels before operating.

Failure to do so can result in death or electrical shock.

NOTE: These checks are done with the dryer unplugged or disconnected from power.

TEST #1: Supply Connections

This test assumes that proper voltage is present at the outlet, and visual inspection indicates that the power cord is securely fastened to the terminal block (electric dryer) or wire harness connection (gas dryer).

ELECTRIC DRYER

1. Unplug dryer or disconnect power.
2. Remove the cover plate from the upper right corner of the back of the dryer. (See photo page 6-4).
3. With an ohmmeter, check for continuity (0Ω) between the neutral (N) terminal of the plug and the left contact on the terminal block. See illustration in right column.
 - If there is no continuity (0Ω), make sure the white wire is at the left position on the terminal block. If not correct the wiring. If it is, then replace the power cord and test the dryer.
 - If wired correctly and there is continuity (0Ω), go to step 4.

4. In a similar way, check which terminal of the plug is connected to the right-most contact on the terminal block and make a note of it. This will be L1 (black wire) in the wiring diagram.

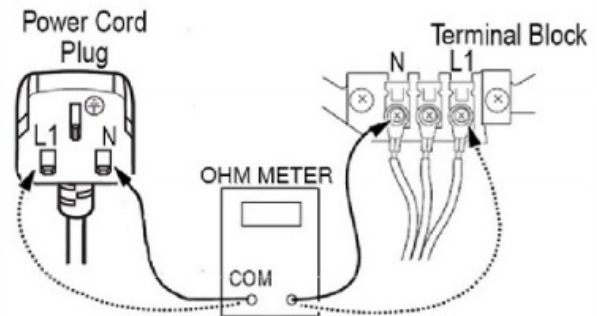

- When this is found, it is used in step 5.
 - If none of the plug terminals have continuity (0Ω) with the left-most contact of the terminal block, replace the power cord and test the dryer
 - Do the same with right-most terminal.
5. Access the machine control electronics without disconnecting any wiring to the dryer control boards.
 6. On model 22: with an ohmmeter, check for continuity (0Ω) between the L1 terminal of the plug (found in step 4) and black wire on the dryer step down transformer.

On model 25: with an ohmmeter, check for continuity (0Ω) between the L1 terminal of the plug (found in step 4) and black wire at terminal P9-2 on CCU.

- If there is continuity (0Ω), go to step 7.
- If there is no continuity, check that wires on the terminal block are mechanically secure. If not, tighten securely, if this cannot be accomplished, replace the terminal block assembly. If secured tightly, and no continuity, replace the main wire harness and test the dryer.

1. On model 22: Check for continuity (0 Ω) between the neutral (N) terminal of the plug and white wire on the step down transformer.

On model 25: Check for continuity (0 Ω) between the neutral (N) terminal of the plug and blue wire at P8-3 on the CCU.

 - If there is continuity (0 Ω), go to step 8.
 - If there is no continuity and the mechanical connections of the wires are secure, replace the main wire harness.
2. Model 22 and 25: visually check that the UIC transformer is connected to the UIC at AA6, and no wires are loose in the connector. Check also the two wire connector at the primary side of the UIC transformer.
3. If steps 6, 7 & 8 pass, visually check that the P2 connector is inserted all the way into the dryer CCU control board.
4. Visually check that all UIC connections are tight and all wires secured into connectors.
5. If all of the visual checks pass, reinstall the console electronics, housing assembly, and all parts and panels before operating.
6. Plug in dryer or reconnect power.
7. Perform the Diagnostic Test to verify repair.
8. If indicators do not light, the dryer UIC electronics have failed:
 - Unplug dryer or disconnect power.
 - Replace the dryer UIC.
 - Reinstall all the parts and panels before operating.
 - Plug in dryer or reconnect power.
 - Perform Diagnostic Test to verify repair.

9. Reinstall the console electronics, console assembly, and all parts and panels before operating.
10. Plug in dryer or reconnect power.
11. Perform the Diagnostic Test to verify repair.
12. If display segment on dryer still does not light, the dryer UIC has failed:
 - Unplug dryer or disconnect power.
 - Replace the UIC.
 - Reinstall all parts and panels before operating.
 - Plug in dryer or reconnect power.
 - Perform diagnostic test to verify repair.

GAS DRYER

1. Unplug dryer or disconnect power.
2. Remove the cover plate from the upper right corner of the back of the dryer.



3. Check that the power cord is firmly connected to the dryer's wire harness. The power cord is in two pieces. Check for continuity (0 Ω) from each plug end to the wire harness connector just inside the cover plate. Check continuity of this power cord while both halves are connected [\(See page 6-3\)](#).
4. Access dryer control electronics without disconnecting any wiring to the controls.

5. With an ohmmeter, check for continuity (0Ω) between the neutral (N) terminal of the plug and white wire (N) of the harness connector. The left-hand side of the illustration below shows the position of the neutral terminal (N) on the power cord plug.

- If there is continuity (0Ω), go to step 6.
- If there is no continuity, or an open circuit (infinite Ω) is found, replace the power cord. Otherwise, go to step 6.

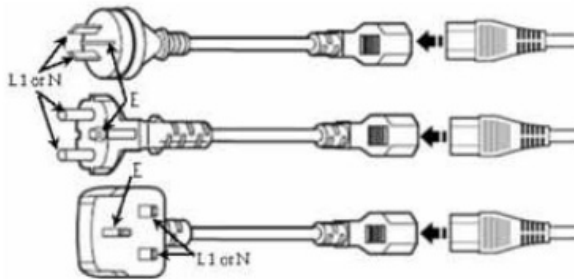

6. In a similar way, check for continuity (0Ω) between the L1 terminal of the plug and black wire at the harness connection.

- If there is continuity (0Ω), go to step 8.
 - If there is no continuity, check for continuity (0Ω) of the power cord in a similar way to that illustrated in step 5, but for power cord's L1 wire.
 - If an open circuit (infinite Ω) is found, replace the power cord. Otherwise, go to step 7.
7. Visually check that the UIC transformer is connected to the UIC at AA6 and no wires are loose in the connector.
8. Visually check that the P2 connector is inserted all the way into the dryer CCU control board.
9. Visually check that all UIC connections are tight and all wires secured into connectors.
10. If all of the visual checks pass, reinstall the console electronics, housing assembly, and all parts and panels before operating.

11. Plug in dryer or reconnect power.
12. Perform the Diagnostic Test to verify repair.
13. If indicators do not light, the dryer UIC electronics have failed:
- Unplug dryer or disconnect power.
 - Replace the dryer UIC.
 - Reinstall all the parts and panels before operating.
 - Plug in dryer or reconnect power.
 - Perform Diagnostic Test to verify repair.
14. If all steps check OK, replace the main wire harness.

TEST #2: Motor Circuit Test

This test will check the wiring to the motor and the motor itself. The following items are part of this motor system:

Part of Motor System	Electric Dryer	Gas Dryer
Harness / connection	yes	yes
Belt / belt switch	yes	yes
Drive motor	yes	yes
Centrifugal switch	yes	yes
Door switches	yes	yes
Machine control ESD info (See page 1-1).	yes	yes

1. Unplug dryer or disconnect power.
2. Check for a broken belt on the dryer drum. If belt is OK, go to step 3.

1. Check the belt switch. Remove the drum belt from the spring loaded idler pulley. Listen for switch to click as the idler arm is moved up and down.

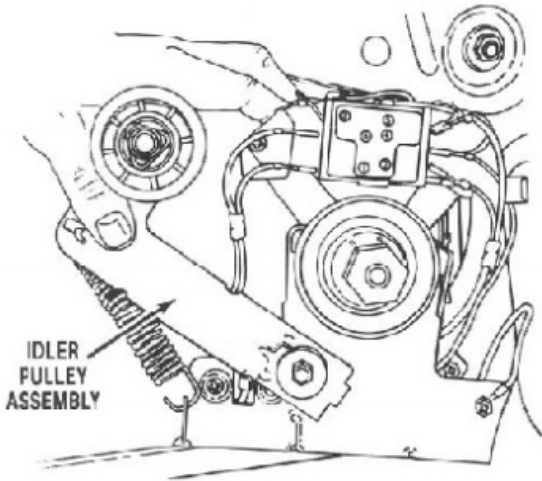

- If no click, replace belt switch.
- If click is heard; check switch for closed circuit (0Ω) by isolating the switch. Take one wire connector off the belt switch.

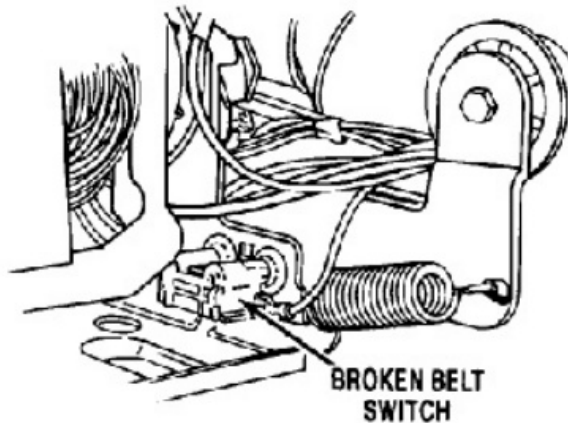

- If the resistance reading goes from infinity to a few ohms as pulley arm closes the switch, belt switch is OK. If not, replace the belt switch.
- If belt switch is OK and there is still an open circuit (infinite Ω), check motor thermal protector, motor windings, and centrifugal switch.

2. Remove wires directly from Motor Switch.

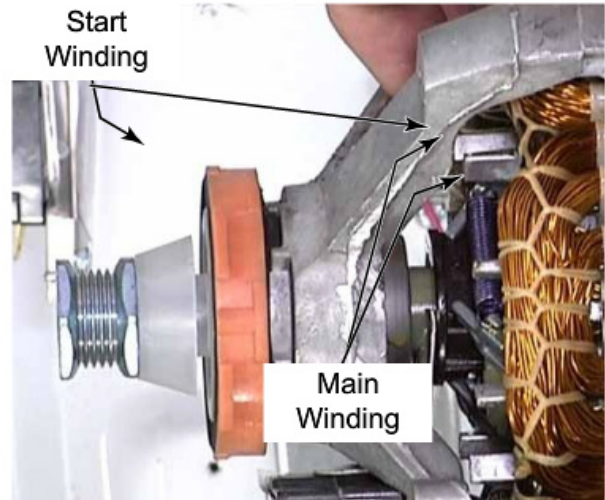

3. Check for the resistance values of the motor's Main and Start winding coils as shown in chart.

NOTE: Main and Start winding coils must be checked at the motor with wires disconnected from centrifugal switch.

Winding	Resistance (Ω)	Contact Points of Measurement
MAIN	14.8 - 15.2 Ω	4M to 5M Blue and White wires coming out of the motor.
START	14.8 - 15.2 Ω	3M to 4M Blue and Violet wires coming out of the motor.

- If the resistance at the motor is correct, there is an open circuit (infinite Ω) between the motor and the machine control electronics.
- If the Start winding is in question and the resistance is much greater than 15.2Ω, replace the motor.

4. Door Switch problems can be uncovered in the Door Switch Test #4. However, if this was not done, the following can be done without applying power to the dryer.

- Connect an ohmmeter to neutral, and the white connector on terminal P4 of the CCU.
- With the door properly closed, the ohmmeter should indicate continuity (0–2Ω).
- If not, isolate the two door switches, test individually as explained in step 3.

5. Replace the failed door switch(es).

TEST #3: Heater Test

This test is performed when either of the following situations occur:

- Dryer does not heat
- Heat will not shut off

This test checks the components making up the heating circuit. The following items are part of this system:

Part of Heating system	Electric Dryer	Gas Dryer
Harness / connection	yes	yes
Heater relay	yes	yes
High temp cutout	yes	yes
Thermal fuse	yes	yes
High temp thermostat	yes	yes
Heat element assembly	yes	no
Gas burner assembly	no	yes
Centrifugal switch	yes	yes
Exhaust thermistor	yes	yes
Machine control electronics. See ESD information.	yes	yes
Console electronics and housing assembly	yes	yes
Gas supply	no	yes

Dryer does not heat:

ELECTRIC DRYER:

1. Unplug dryer or disconnect power.
2. Remove the service panel to access the thermal components.
3. Using an ohmmeter and referring to the wiring diagram, measure the resistance between the red wire and red & white wires on the heater coil.

- If the resistance when cold is between 11 and 16Ω, go to step 5.
- If an open circuit (infinite Ω) is detected, replace heater coil.

4. Test thermostat circuit, if closed circuit (0Ω) is found, go to step 5, if open circuit (infinite Ω) is detected, visually check the wire connections to the high temp cutout, high temp thermostat, thermal fuse, and heater coil. If connections look good, check for continuity (0 Ω) across each of these components. Replace both the high temp cutout and high temp thermostat, if either one is electrically open.

- To check the thermostat circuit, check for closed circuit (0Ω) between the heat relay red wire and red white stripe wire on the heater coil.

5. If heater coil and thermostat circuit check OK, check centrifugal switch 1M to 2M.

- Manually close motor switch while checking for closed circuit (0Ω) between 1M and 2M.

- If no closed circuit (0Ω) is detected, replace the motor.

- If closed circuit (0Ω) is detected, replace CCU.

GAS DRYER:

1. Unplug dryer or disconnect power.
2. Locate the red wire at the gas valve and the red wire on the thermal fuse that is coming from the control, remove this red wire from the thermal fuse and check resistance from the bare terminal on the thermal fuse to the red wire at the gas valve. If there is continuity (0 Ω) then skip to step 8.
3. Remove the service panel to access the thermal components.
4. Perform TEST #3a. If the thermal fuse is OK, go to step 5.
5. Check thermistor by removing one of the wires and checking resistance across both terminals.
 - If an open circuit (infinite Ω) is detected, replace thermistor. Check readings on chart [\(See page 5-9\)](#).
6. Perform TEST #3b. If the high temp cutout is OK, go to step 7.
7. Locate the high temp thermostat. Remove the wires from it. Measure the continuity through it by touching the meter probes on the bared terminals.
 - If there is an open circuit (infinite Ω), replace the high temp thermostat and high temp cutout as a set.
 - Otherwise, go to step 8.
8. Perform TEST #3c (Gas Valve Test). If this is OK, go to step 9.

9. If heater coil and thermostat circuit check OK, check centrifugal switch 1M to 2M.

- Manually close motor switch while checking for closed circuit (0 Ω) between 1M and 2M.
- If no closed circuit (0 Ω) is detected, replace the motor.
- If closed circuit (0 Ω) is detected, replace CCU.

Dryer will not shut off:

1. Unplug dryer or disconnect power.
2. Check for shorted electric heat coil to the coil heater casing.
 - If closed circuit (0 Ω) between coil and heater casing is detected, replace heater coil.
3. Look for shorted terminals on the thermistor. Sometimes small metal objects will fall across the two terminals of the thermistor and short them together.
4. Check thermistor resistance and compare to chart, [\(See page 5-9\)](#).
5. Remove the red and black wires from the heat relay on the CCU. Check for infinite resistance between the two terminals of the heat relay.
 - If closed circuit (0 Ω) is detected with no power to dryer, replace CCU.

TEST #3a: Thermal Fuse Test

1. Unplug dryer or disconnect power.
2. Access the thermal fuse to the left of the thermistor on top of the blower housing.
3. Disconnect one wire from thermal fuse. Using an ohmmeter, check continuity across the thermal fuse.
 - If the ohmmeter indicates an open circuit (infinite Ω), replace the failed thermal fuse, and check for blocked or restricted lint filter or outlet grill.
 - If OK, check for restricted air intake or for reduced make up air.

TEST #3b: High Temp Cutout Test

If the dryer does not produce heat, check the status of the high temp cutout.

1. Unplug dryer or disconnect power.
2. Access the high temp cutout on the burner cone or heater box.
3. Using an ohmmeter, check the Continuity across the high temp cutout after removing at least one wire from it.
 - If the ohmmeter indicates an open circuit (infinite Ω), replace the failed high temp cutout and high temp thermostat. In addition, check for blocked or improper exhaust system, or shorted heat element (electric dryer).
 - To check for shorted heat element remove both wires from heat coil connectors and check the resistance between the two terminals. Resistance should be about 11Ω when coil is at room temperature.

TEST #3c: Gas Valve Test

1. Unplug dryer or disconnect power.
2. Access the gas valve.

Use an ohmmeter to determine if a gas valve coil has failed. Remove harness plugs. Measure resistance across terminals. Readings should match those shown in the following chart. If not, replace coil.

Terminals	Resistance
1 to 2	1760 Ω $\pm 5\%$
1 to 3	720 Ω $\pm 5\%$
4 to 5	1740 Ω $\pm 5\%$

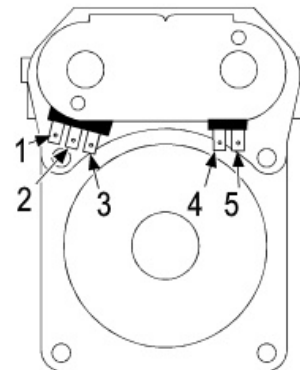

IMPORTANT:

Make sure all harness wires are looped back through the strain relief after checking or replacing coils.

TEST #4: Door Switch Test

Activate Diagnostic Test Mode, and perform a Door Switch Test. Functionality can be verified by the appearance of a degree symbol above a digit each time door is closed, but goes away when the door is opened again.

If the Door Switch Test does not reveal the degree symbol (small circle above the digit) in the display when the door is closed:

- Unplug dryer or disconnect power.
- Visually check door switch wire connectors behind service panel. If the connections are OK, continue on.

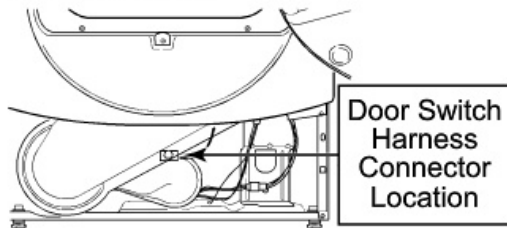

- Check that the wires between the door switch and P8-4 on the CCU are connected.
- Check for closed circuit (0Ω) from neutral to P8-4 on the CCU. Opening and closing the door should change the reading on the meter, if not, isolate the door switches individually and test each switch for a closed circuit (0Ω) when button on switch is held down. Replace defective door switch(es) as needed.
- If wiring test OK and door switch assembly is OK or has been replaced, and the dryer still does not start, replace the CCU.

TEST #5 Exhaust Temperature Test:

1. Hold a thermometer capable of reading from 32° to 82°C (90° to 180°F) in the center of the exhaust outlet. The correct exhaust temperatures are as follows:

STACK EXHAUST TEMPERATURES		
FABRIC SETTING	HEAT TURNS OFF*	HEAT TURNS ON
Whites And Colors	$76.6^{\circ} \pm 3^{\circ}\text{C}$ ($170^{\circ} \pm 5^{\circ}\text{F}$)	11-16° C (25-30° F) Below the heat turn off temperature
Perm. Press	$76.6^{\circ} \pm 3^{\circ}\text{C}$ ($170^{\circ} \pm 5^{\circ}\text{F}$)	
Delicates	$65.6^{\circ} \pm 3^{\circ}\text{C}$ ($150^{\circ} \pm 5^{\circ}\text{F}$)	

* Check the cut-in and cut-out temperature 3 to 4 times to get the average. Dryer will cycle much quicker without clothes in the drum.

2. If the exhaust temperature is not within specified limits, unplug dryer or disconnect power. See dryer does not heat (See page 6-7).

• If thermostats check OK look for exhaust restrictions or limited make up air.

NOTE: Do not take the dryer test temperature from inside the drum.

TROUBLESHOOTING DRYER OPERATION

Dryer will not run

- Is there anything in the display lit?

If not, check incoming voltage and UIC transformer connections.

If so, on model 22 dryers, check step down transformer connections. If so, on model 25 dryers, check CCU for line voltage from L1 to P8-3

- Has a household fuse blown, or has a circuit breaker tripped?

There may be 2 fuses or circuit breakers for an electric dryer. Check that both fuses are intact and tight, or that both circuit breakers have not tripped. Replace the fuse or reset the circuit breaker. If the problem continues, call an electrician.

- Was a regular fuse used?

Use a time-delay fuse.

- Is the correct power supply available?

Dryers require a 240-volt power supply, delivering 20 amps of current.

- Is the dryer door firmly closed?

- Listen for the door switch(es)?
If they can't be heard, replace the switch(es).

- Did "Select Cycle" ever display?

- For PD dryers, make sure money is being accepted and credited toward a cycle. For PN dryers, make sure cycle price is set to 6 00 for free vend.

- Was the cycle button pressed firmly?

If yes, try a different cycle selection button, if that works, replace membrane switch.

Dryer displaying F or D codes

- If F or D code is displayed, check the proper tech sheet and proper diagnostic procedures.
- A blank screen when power is applied may indicate a failure mode, enter diagnostics mode to get the code displayed then check the diagnostic codes table.
- Cannot enter diagnostic mode or display shows no failure code, check UIC transformer primary connection.

Primary voltage good, check secondary on UIC transformer. For correct secondary voltages, (See page 5-12). If voltages are incorrect, replace the UIC transformer.

Unusual sounds

- Has the dryer had a period of non-use?

If the dryer hasn't been used for a while, there may be a thumping sound during the first few minutes of operation.

- Is a coin, button or paper clip caught between the drum seal and front or rear bulkheads of the dryer?

Check felt seals for stuck small objects.

- Is it a gas dryer?

Gas valve clicking is a normal sound.

- Are the 4 legs installed, and is the dryer level front to back and side to side?

The dryer may vibrate if not properly installed. See installation instructions.

Excessive vibration can also be due to missing vibration pad under the motor bracket. (See page 4-28).

- Is the clothing knotted or balled up?

When balled up, the load will bounce, causing the dryer to vibrate. Separate the load items and restart the dryer.

- Is the noise from the blower?

Lint balls in blower wheel causes noise. A cracked blower wheel causes excess noise.

- Is the vent connected to the dryer?

Dryer makes more noise with the vent off.

Dryer display flashes in user mode

- Make sure coin box is inserted all the way and locked in place.

- Check physical position of vault switch.

If position is correct check switch wiring and harness connections.

If wiring checks OK, check AA1 connector on control board.

- Unplug dryer and AA1 connector from control board, check continuity between the black and orange wires in the connector.

Continuity not found, recheck the wire harness and connectors from AA1 connector to vault switch. Replace the switch wire harness if no problem can be found and the switch checks out fine.

Continuity is good, reinstall the AA1 connector and check operation. If display is still flashing, make sure coin box is deep enough to engage coin vault switch. If so, replace the UIC.

Dryer reverts to default options

- Set-up the desired options and save the settings. Unplug the dryer for 15 seconds. Reapply power to dryer, if operator desired options revert to factory defaults, replace control board.

TROUBLESHOOTING DRYER RESULTS

Clothes are not drying satisfactorily, drying times too long, or load is too hot

- **Is the lint screen clogged with lint?**
Lint screen should be cleaned before each load.
- **Is the exhaust vent diameter the correct size?**
Use 10.2 cm (4") diameter vent material.
- **Is the exhaust vent of outside exhaust hood clogged with lint, restricting air movement?**
Run the dryer for 5 - 10 minutes. Feel under the outside exhaust hood to check for air movement. If there is no air movement, clean exhaust system of lint or replace exhaust vent with rigid metal or flexible metal vent. See venting requirements.
- **Are dryers vented to a common exhaust?**
If so, are back draft dampers installed on each dryers exhaust?
- **Are legs installed on the dryer?**
If not, install legs.
- **Is the dryer located in a room with temperatures below 7°C (45°F)?**
Proper operation of dryer Cycles requires supply air temperatures above 7°C (45°F).
- **Are fabric softener sheets blocking the grille?**
Use only one fabric softener sheet, and use it only once.
Extremely small loads will not push fabric softener sheets off outlet grill.
- **Is the dryer located in a closet?**
Closet doors must have ventilation openings at the top and bottom of the door. The front of the dryer requires a minimum of 2.54 cm (1") of airspace, and, for most installations, the rear of the dryer requires 10.2 cm (4").
- **Is the lint filter screen blocked with dried on softener?**
If so, clean with laundry detergent and warm water.
- **Is the load too large and heavy to dry quickly?**
Separate the load to tumble freely.
Check washer for proper spin speeds and moisture extraction.
- **Is the exhaust vent the correct length?**
Check that the exhaust vent is not too long or has too many turns. Long venting will increase drying times. Back pressure measured at the exhaust outlet of the dryer should be less than 1" but more than 0" water column. See venting requirements.
- **Has the fuel been changed to LP gas?**
If so has the gas valve been converted correctly?
- **Gas dryers: Is the wrong orifice being used.**
Install the correct orifice.
- **Is supply voltage at least 220 volts?**
Lower incoming voltage can reduce the wattage output of an electric element.
- **Is make-up air available to compensate for all dryers in the room?**
Make up air is calculated at 155 square centimeters (24 square inches) per dryer.

Lint on load

- **Is the lint screen clogged?**

Clean lint screen. Check for air movement.

Check for proper detergent use in washer.

- **Is dryer vent restricted?**

Clean vent. Replace crushed vent. Use only rigid metal vent material.

Stains on load or drum

- **Was dryer fabric softener properly used?**

Add dryer fabric softener sheets at the beginning of the cycle. Fabric softener sheets added to a partially dried load can stain garments.

- **Is the drum stained?**

Drum stains can be caused by dyes in clothing (usually blue jeans). This will not transfer to other clothing.

- **Is gap forming at bottom of drum near felt seals?**

Replace worn drum rollers.

- **Is staining a black oily soot that can be wiped off or smeared with your finger?**

Black oily soot on the drum and clothes can be caused by a dryer not set-up properly to use LP gas.

- **Are there black streaks on the clothing?**

Black streaks on clothes can come from a deteriorating bellow on a front load washer. Replace bellow.

- **Is lint built up on clothes?**

Lint build up can occur if outlet grill is blocked with lint or paper. Remove and clean outlet grill.

Loads are wrinkled

- **Was the load removed from dryer at the end of the cycle?**

Allowing clothes to set too long in the dryer after the cycle is complete may set wrinkles.

- **Was the dryer overloaded?**

Dry smaller loads that can tumble freely.

- **Check for proper cool down period at cycle end.**

Hot clothes left to sit will set wrinkles more easily.

Odors

- **Was there painting, staining or varnishing being done in the area where the dryer is located?**

If so, ventilate the area. When the odors or fumes are gone from the area, rewash and dry the clothing.

- **Is the dryer being used for the first time?**

The new electric heating element may have an odor. The odor will be gone after the first cycle.

- **Is there lint building up in base of dryer?**

Lint build up in the base of the dryer can cause flash which causes odor in clothes

DIAGNOSTIC MODE

This mode is entered by depressing DELICATES for one second while in set-up code 6 (or while dAS displays if operating with Maytag Data Acquisition setup) or with a diagnostic code present. Diagnostic codes are cleared on entry and all display segments should flash. If a diagnostic code persists, it must be corrected before the diagnostic cycle may be executed.

There are 2 procedures to initiate cycle activity from diagnostic mode for these models:

1. **Dryer Field Diagnostic Cycle** – With the entire display flashing, the cycle is started by pressing the PERM. PRESS button. The cycle consists of 7 minutes of heat and 1 minute of cool down. The WHITES AND COLORS button will increment the diagnostic cycle minutes up to 99, then roll over to 2 minutes. Pressing the DELICATES button will cancel this cycle and exit the diagnostic mode.

DRYER HELP MODE

Dryer help mode is entered by pressing the WHITES & COLORS button while in set-up option 2.XX (or while dAS displays if operating with Maytag Data Acquisition setup). In help mode, the software revision is displayed in the digits. Press the WHITES & COLORS button at any time to exit help mode.

Help Code	Description
71	Generation 2 debit card cycle polling message out of sequence.
74	Generation 2 debit card remaining balance message out of sequence.
75	Generation 2 debit card new card balance message out of sequence.
88	Invalid messaging state found in da communications comm_suprv () routine

In the Help Mode, other display symbols and elements are used to reflect the state of various inputs and outputs as follows:

- *low voltage present
- ° (symbol above digit)door closed
- ORmotor sensed running
- AIRheater/gas valve relay on
- FLUFFmotor relay on

CENTRAL CONTROL UNIT (CCU) CONNECTIONS

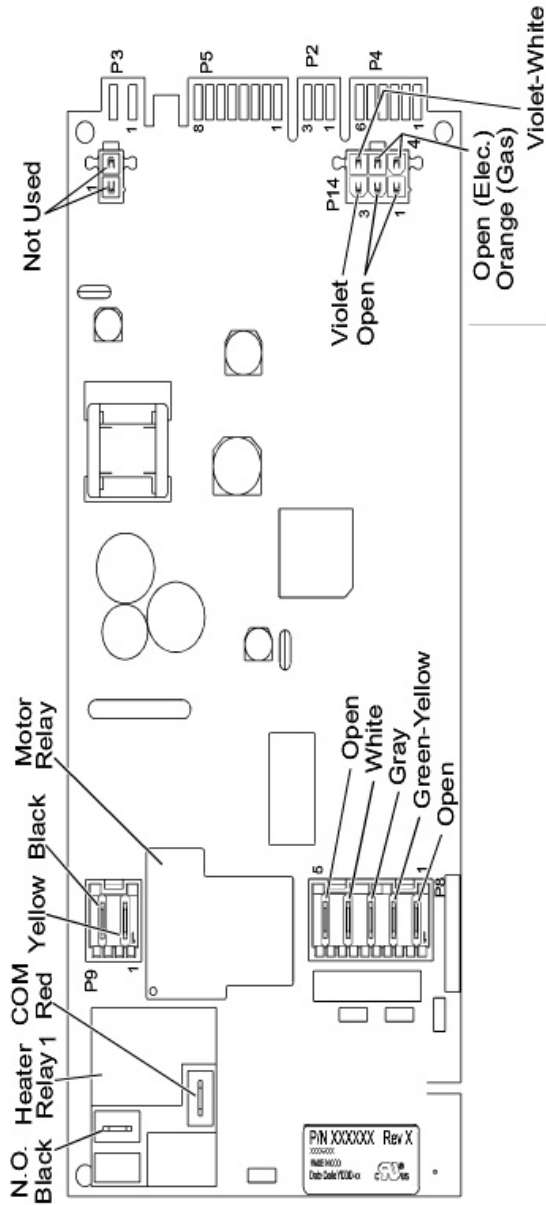

USER INTERFACE CONTROL (UIC) CONNECTIONS

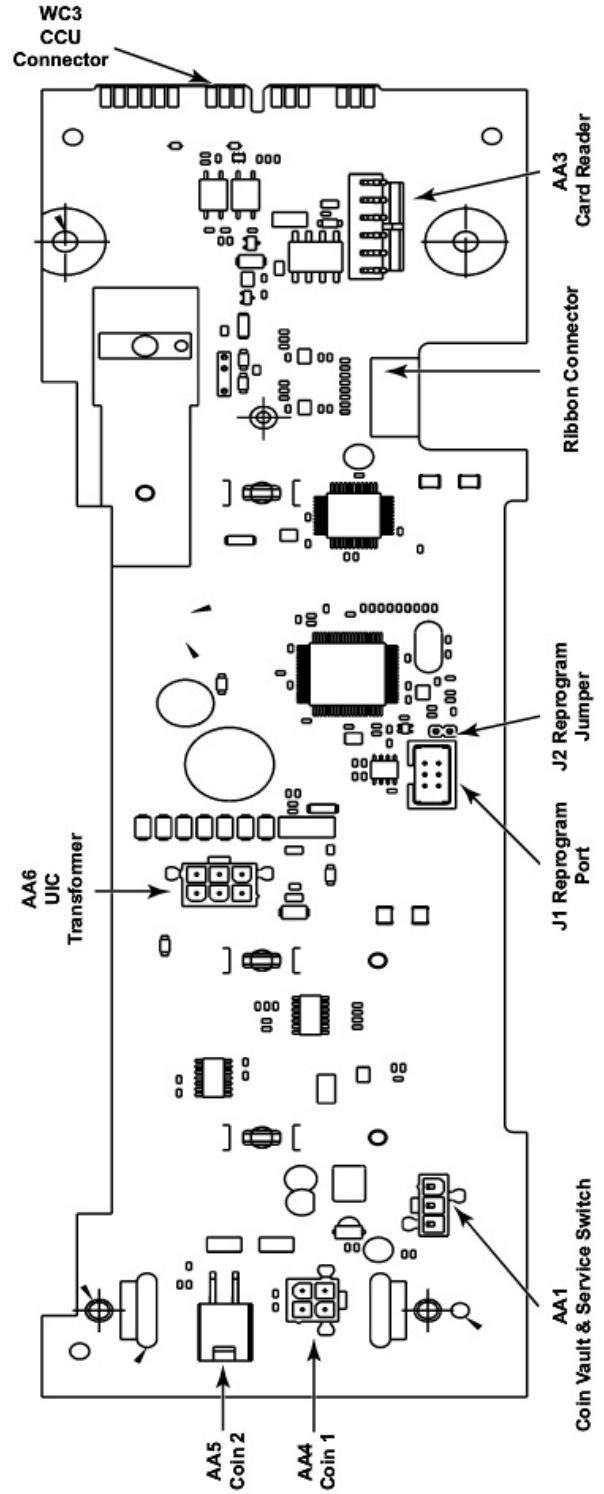

WIRING DIAGRAMS

MODEL 22 PD ELECTRIC MODELS

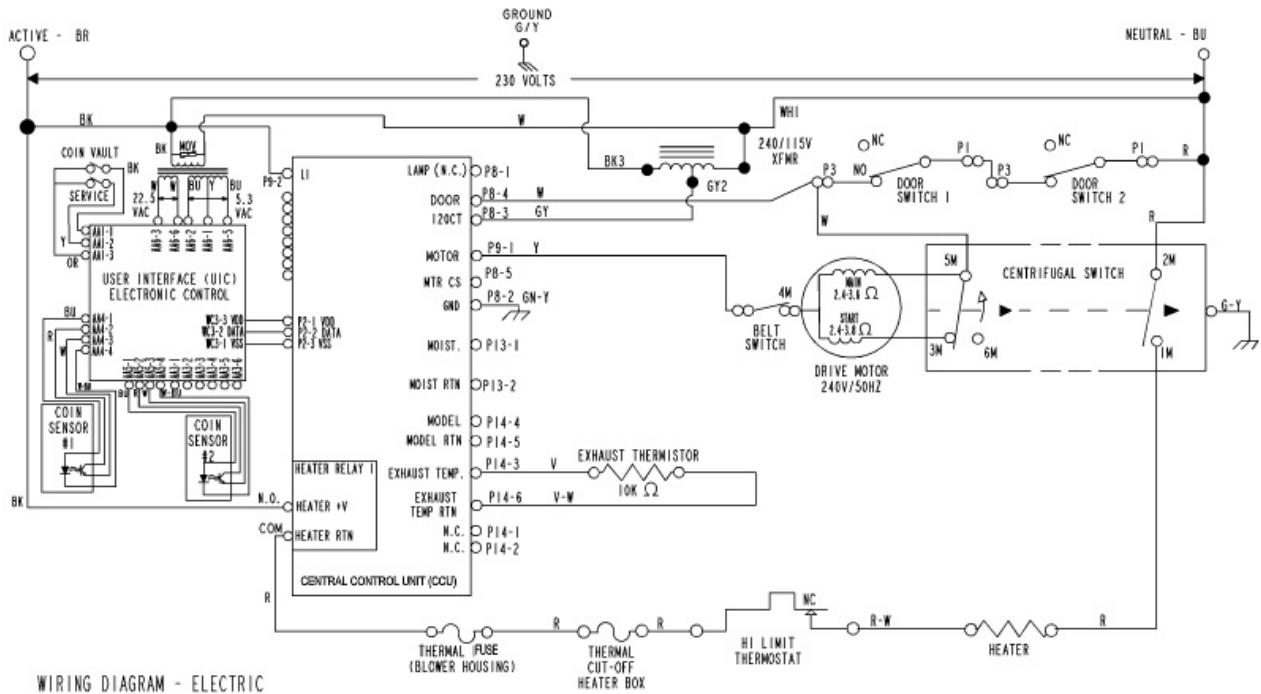

MODEL 22 PD GAS MODELS

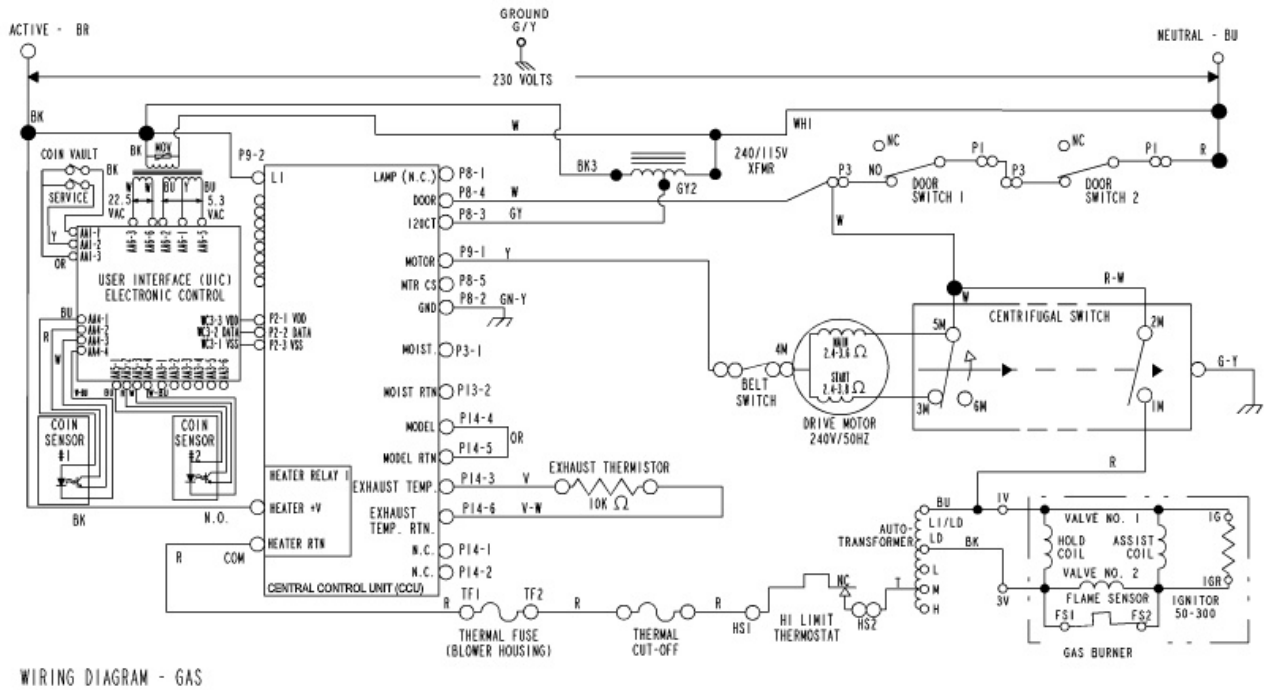

MODEL 22 PN ELECTRIC MODELS

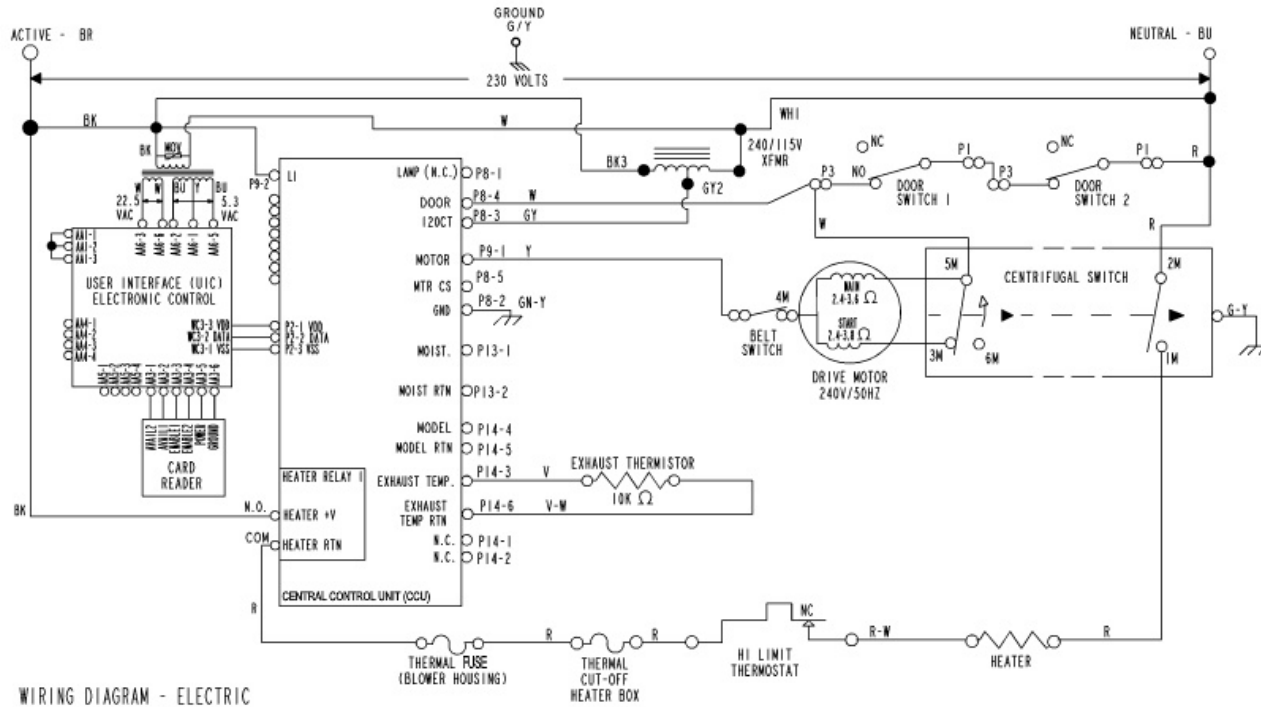

MODEL 22 PN GAS MODELS

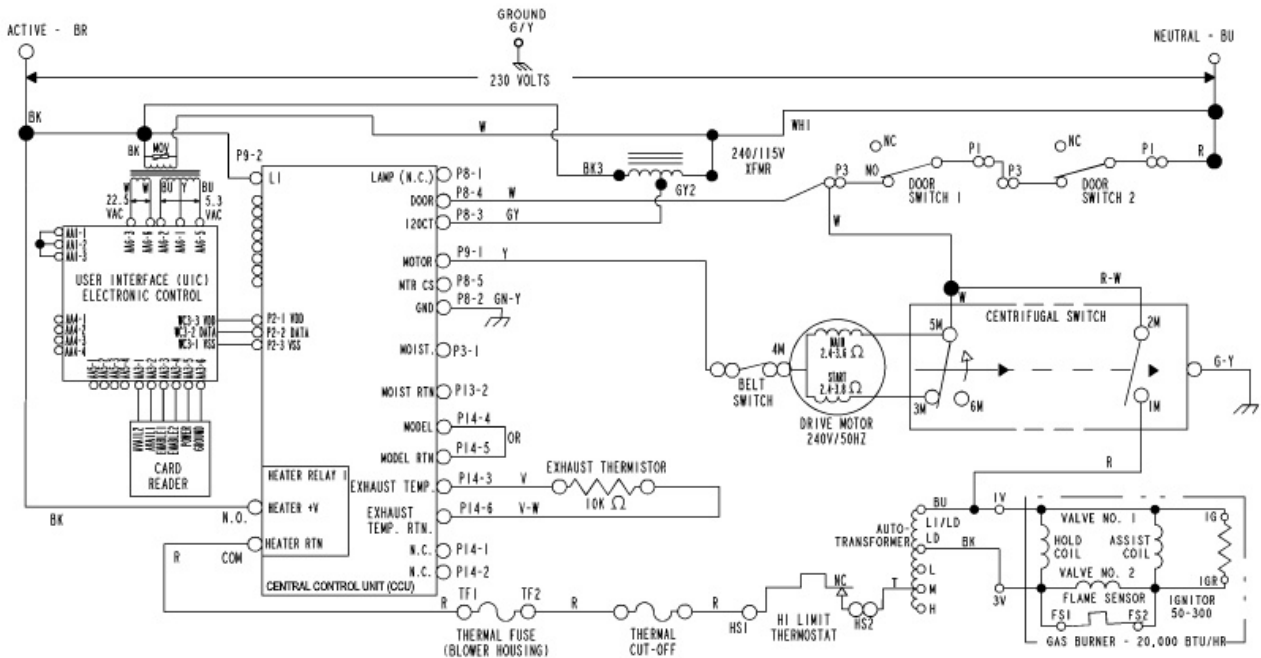

MODEL 25/28 PD ELECTRIC MODELS

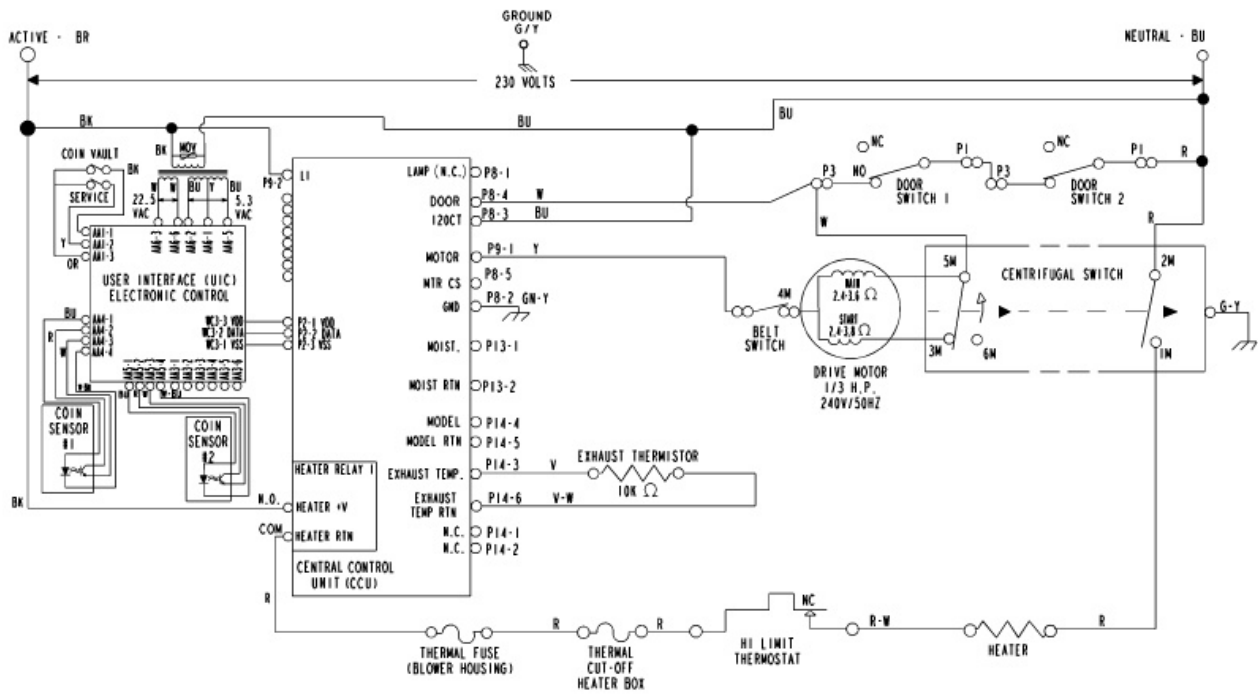

MODEL 25/28 PD GAS MODELS

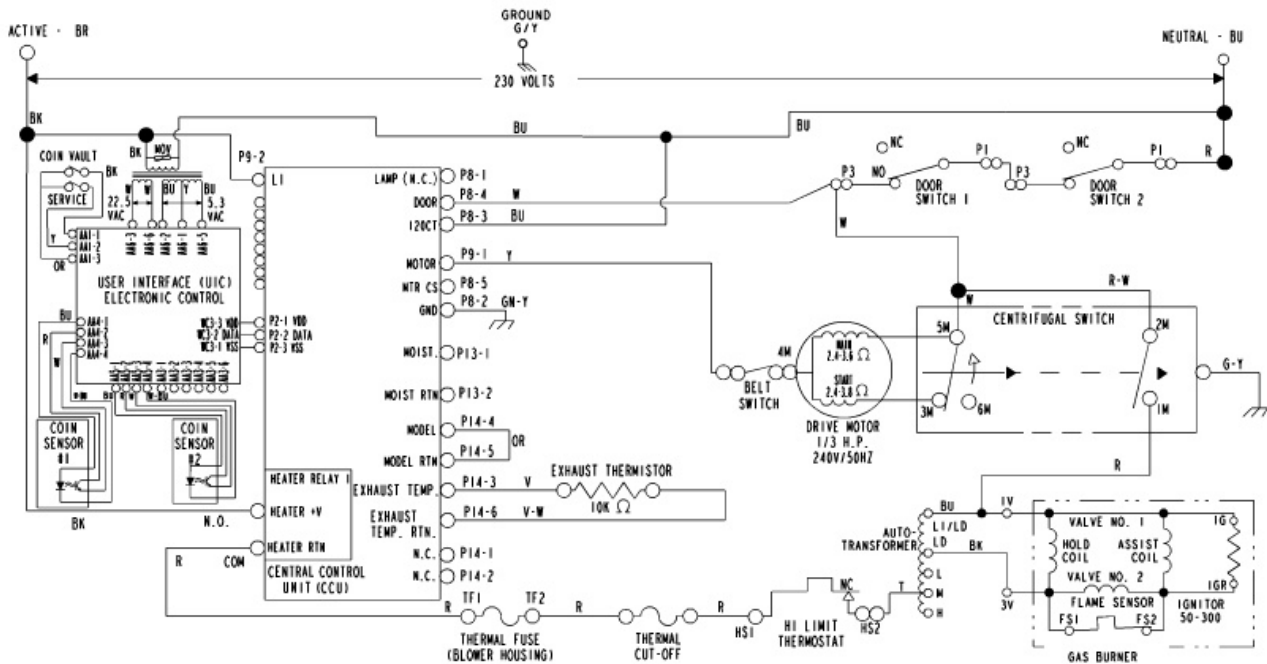

MODEL 25/28 PN ELECTRIC MODELS

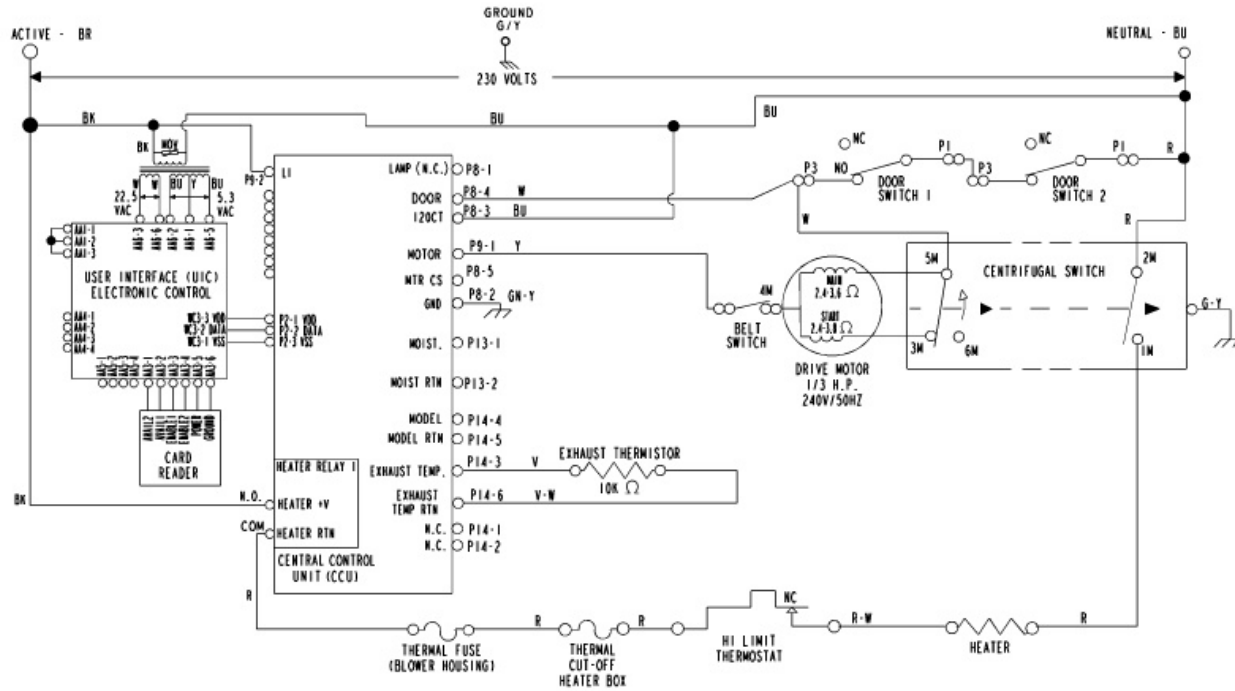

MODEL 25/28 PN GAS MODELS

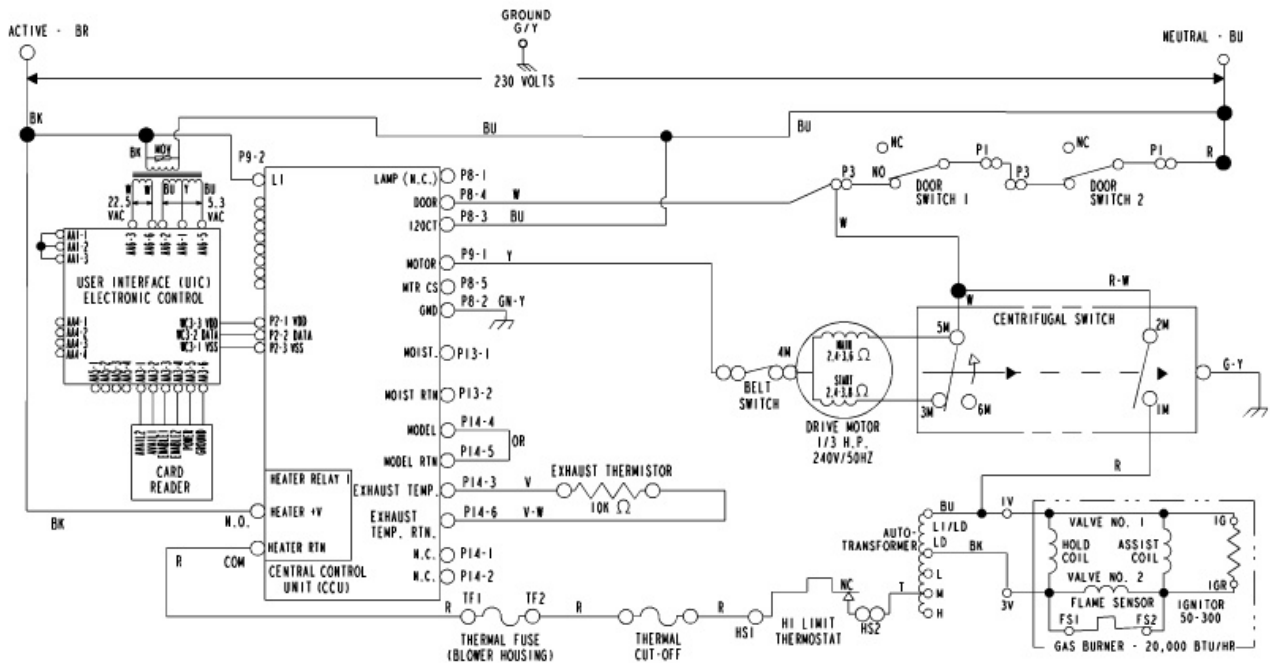

— NOTES —

