

DAILY REFERENCE GUIDE

THANK YOU FOR PURCHASING A WHIRLPOOL PRODUCT



To receive more comprehensive help and support, please register your product at www.whirlpool.eu/register



You can download the Safety Instructions and the Use and Care Guide by visiting our website docs.whirlpool.eu and following the instructions on the back of this booklet.

! Before using the appliance carefully read the Health and Safety guide.

PRODUCT DESCRIPTION

APPLIANCE

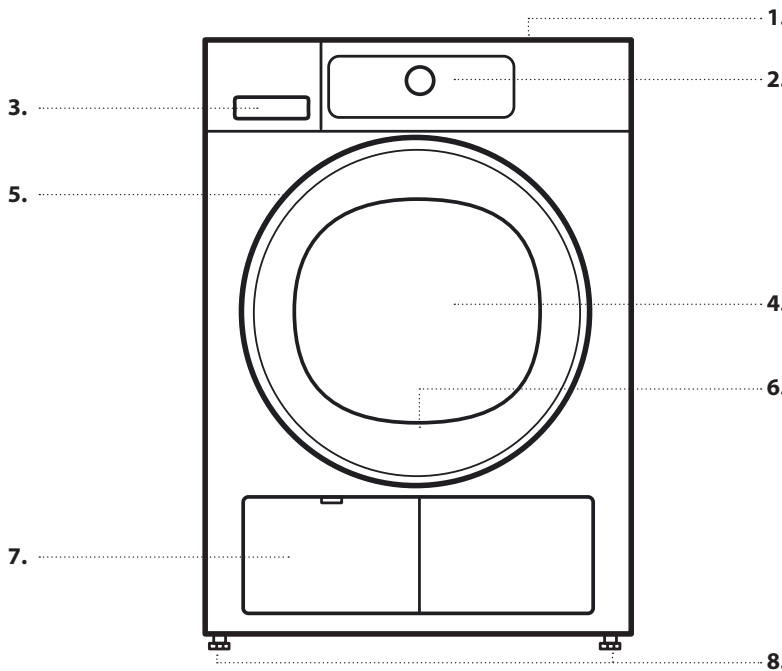

- 1. Worktop
- 2. Control panel
- 3. Water tank
- 4. Door
- 5. Door handle
- 6. Door filter (behind door)
- 7. Bottom filter (behind flap)
- 8. Adjustable feet (4)

CONTROL PANEL

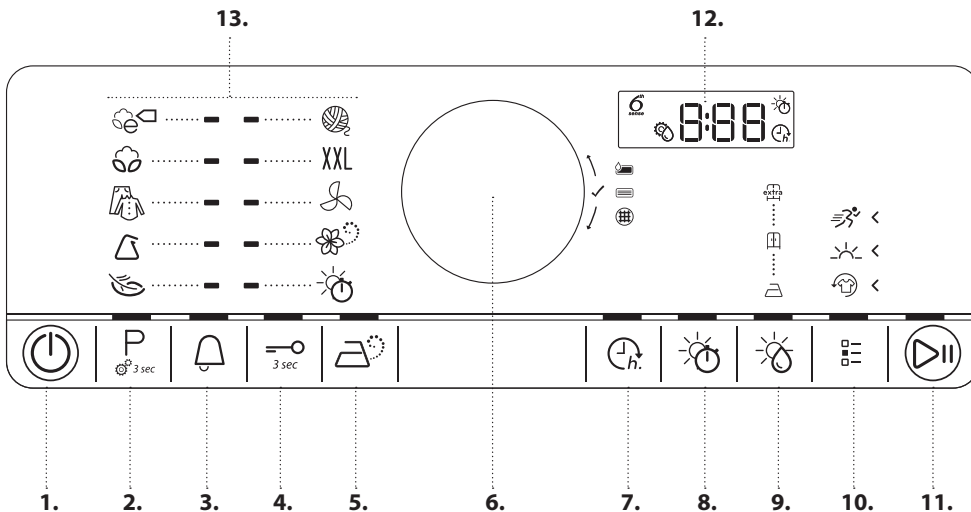

- 1. On/Off button (Reset if long pressed)
- 2. Programme button (Water conductivity setting if long pressed)
- 3. Cycle end alert
- 4. Key lock
- 5. Steam option
- 6. Knob (Turn to select / Press to confirm)
- 7. Start delay
- 8. Drying time
- 9. Dryness level
- 10. Options button
- 11. Start / Pause button
- 12. Display
- 13. Programmes area

FIRST TIME USE

BEFORE USING THE DRYER

CHECK DRAIN HOSE AND WATER TANK

Make sure that the drain hose on the back of the dryer is fixed correctly, either to the dryer's water tank (see picture), or to your domestic sewage system (see Installation guide).

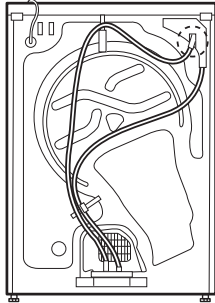

Also make sure that the water tank is correctly inserted.

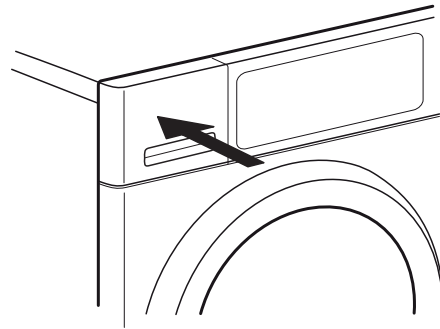

The dryer should be installed in an ambient room temperature of between 20 to 23°C for optimum performance. But will function if the room is between 14 and 30°C.

DAILY USE

See Use and Care Guide for more details on functions / see last page for information on how to obtain the Use and Care Guide

⚠ WARNING

Make sure that no lighters or matches remain in the laundry.

Make sure that the laundry is not soaked with flammable liquids.

1. LOAD LAUNDRY

Prepare your laundry according to the recommendations in section **HINTS AND TIPS**.
Make sure that pockets are empty, fasteners closed and ribbons tied together.



Open the door and load the laundry. Observe the maximum load sizes given in the **PROGRAMME CHART**.



2. CLOSE DOOR

Make sure that no laundry gets stuck between door glass and door filter.



Close the door so that you can hear it click shut.

3. SWITCH ON DRYER

Press the *On/Off button* « until the programme button lights up. An animation occurs, and there is a sound. Afterwards the dryer is ready to be operated.

4. SET THE DESIRED PROGRAMME

GUIDED MODE – the button light will guide you through setting your programme in the following order: selection of programme / drying time (ONLY if *Drying time* or *Airing programme* is selected) / dryness level (only if selectable / adjustable) / options. As soon as you confirm a selection by pressing the knob, the button light will jump to the next step.

Select programme:

Make sure that the *Programme button* « lights up. Turn the knob to select the desired programme. The indicator next to the selected programme lights up. Confirm the desired programme by pressing the knob.

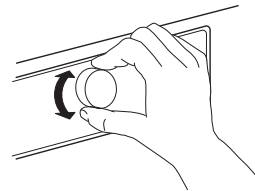

1

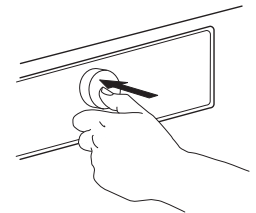

2

Find more information regarding programmes in the **PROGRAMME CHART**.

Select Drying time, if needed

Only if you have selected programme *Drying time* or *Airing* «, you can set the desired drying time from a minimum of 10 minutes to maximum 180 minutes (three hours).
Make sure that the *Drying time button* lights up.

Turn the knob to select the desired drying time. Confirm it by pressing the knob.



Set dryness level, if needed

If you want to change the dryness level, make sure that the *Dryness level button* « lights up.

Turn the knob to select the desired dryness level, then press the knob to confirm.



Select options, if needed

If you want to select additional options, make sure that the *Options button* « lights up. The options which are selectable for your programme are indicated by lighting arrows.



Turn the knob to select the desired options. The symbol of the selected option will blink. To confirm it, press the knob.

Some options / functions can be selected by directly pressing the button.



Refer to section **OPTIONS, FUNCTIONS AND INDICATORS** for more information.

INDIVIDUAL MODE

After you have switched on the dryer, you are not forced to follow the **GUIDED MODE**.

It is up to you which order you choose to set your programme. To do a setting, first press the relevant button, then turn the knob to select, and finally press the knob to confirm.

The variety of options and dryness levels depends on the programme selected. Therefore it is recommended to start your setting with selecting the programme.

5. START PROGRAMME



Press and hold *Start/Pause* « until the button lights up solidly; the drying process starts.

The duration can be recalculated and adapted in the course of the programme.

During such phases, an animation occurs on the display.

6. CHANGE THE SETTINGS OF A RUNNING PROGRAMME, IF NEEDED

You can still change some settings after a programme was started:

- Adjust drying time (only if programme *Drying time* is selected)
- Add or cancel an option, provided the progress of the programme still allows it.

Press the relevant button. The selected setting will blink for a few seconds.

While blinking, you can adjust the setting by turning the knob. If the value or setting stopped blinking, press the button again.

Press the knob to confirm the modification. If you do not confirm, the modification will be confirmed automatically — the modified setting will stop blinking.

The programme will continue automatically.

To change the settings of a running programme or start delay, you can also:

- press *Start/Pause* to put the running programme on pause
- change your settings
- press *Start/Pause* again to continue the programme.



7. RESET A RUNNING PROGRAMME, IF NEEDED

Press and hold the *On/Off button* « until "rES" appears on the display.



The programme is ended afterwards. Immediately open the door and unload the laundry, so that eventual heat in the laundry can dissipate.



8. SWITCH OFF THE DRYER AFTER PROGRAMME END

At the end of the programme, „End“ appears on the display. Press *On/Off* « to switch off the dryer. Open the door and take out your laundry.



The dryer will switch off automatically in about a quarter of an hour after programme end, to save energy.

9. EMPTY WATER TANK / CLEAN DOOR FILTER / CLEAN BOTTOM FILTER

Refer to section **CARE AND MAINTENANCE**.

HINTS AND TIPS

Respect the care labels of your laundry; make sure that it is appropriate for being treated in a dryer.

CARE LABELS

The dots indicate the temperature degree for drying the laundry.

 Normal temperature

 Reduced temperature

 Do not tumble dry

EMPTY ALL POCKETS

Objects like coins or keys can damage your laundry as well as the drum.

ADAPTING THE DRYER TO WATER CONDUCTIVITY

The drying results are affected by the conductivity of the water used during washing. If, by modifying the available dryness levels (iron dry; cupboard dry; extra dry), you are not satisfied with the final drying results, you can adapt the water conductivity level. The dryer comes with preset level 2. Choose between level 1 (most damp results) and 5 (most dry results).

Press and hold the *Programme button* until the *Conductivity Adjustment symbol* on the display blinks.



Turn the knob to adjust the level (1 – 2 – 3 – 4 – 5).

Press the knob to confirm the selected level.

This operation is not needed for every drying cycle. Once the most satisfying water conductivity level has been identified, you no longer need to modify it.

SAVING TIPS

Always dry a full load; this optimizes the relative energy consumption. The maximum load sizes for the various programmes are indicated in the programme chart.

To reduce the drying time, make sure that the laundry is spun with the maximum possible spin speed of the wash programme. This reduces the moisture content in the laundry.

CONSUMPTION DATA

Data can differ in your home, mainly depending on the moisture content of the laundry load.

Programme	Load (Kg)	Spin Speed (rpm)	Humidity (%)	Energy consumption (kWh)	Drying Time (min)
ECO COTTON *	10	1000	60	2.32	280
	5	1000	60	1.29	152
ECO COTTON	10	800	70	2.70	302
	10	1400	50	2.13	219
COTTON IRON DRY	10	800	70	2.46	281
	10	1000	60	2.19	242
	10	1400	50	1.92	203
SYNTHETICS CUPBOARD DRY	3.5	1000	40	0.94	71

*Reference programmes for Energy Label / Regulation 392/2012 / EU Values are based on the default programme setting, with clean door and bottom filter. For consumer tests, the door filter and bottom filter need to be cleaned after each cycle.

For tests according EN 61121, the appliance shall be installed using direct drain (see INSTALLATION GUIDE). The water shall be collected in an external container for proper measurement.

HEAT PUMP SYSTEM

This dryer is fitted with a sealed heat pump system to dry your clothes. To operate, the heat pump contains fluorinated greenhouse gases (Fgases) which are covered by the Kyoto Protocol. These F gases are contained in a hermetically sealed unit. This sealed unit contains 0.34 kg of the F gas R134a which acts as a refrigerant. GWP = 1430 (1 t CO₂).

The energy consumption and drying time may differ from the values above. They depend on the operation conditions in your home (such as voltage fluctuation, mixture of textiles, humidity of the textiles after spinning, load volume).

The values are determined according to European Norm 61121 and refer to the default programme setting; changing the setting also impacts the consumption data.

Power Consumption - Watts	
Left-on mode	1.07
Off-mode	0.40

PROGRAMME CHART

Programme	Care Labels	Max Load (Kg)	Directly selectable			Selectable by options button			
			Dryness level	Steam option	Drying time	Fresh Care	Gentle	Rapid	
ECO COTTON			max		—	—		—	—
COTTON			max		—	—	—	—	—
					✓	—	✓	✓	✓
					—	—	—	—	—
MIXED			2,0	—	✓	—	✓	✓	—
SYNTHETICS			3,5		—	—	—	—	—
					✓	—	✓	✓	—
					—	—	—	—	—
DELICATES			2,5		—	—	✓	—	—
WOOL EXCELLENCE			1,0		—	—	—	—	—
BIG ITEMS	XXL		3,0		—	—	✓	—	—
AIRING			max	—	—	✓	✓	—	—
STEAM REFRESH			1,5	—	—	—	—	—	—
				—	—	—	—	—	—
DRYING TIME			max	—	—	✓	✓	—	—

✓ Selectable / Optional — Not Selectable / Applicable

Maximum load sizes: 10 kg

PROGRAMMES

Make sure that your laundry is suitable to be treated in a tumble dryer. Refer to **HINTS AND TIPS** / Care labels.

ECO COTTON

For drying normally wet cotton laundry. Standard cotton programme, suitable to dry normal wet cotton laundry. Most efficient programme in terms of energy consumption for drying cotton laundry. The values on the Energy Label are based on this programme.



COTTON

For drying cotton laundry.



MIXED

For drying mixed laundry made of cotton, linen, synthetic fibres and their blends.



SYNTHETICS

For drying laundry made of synthetic fibres.



DELICATES

For drying delicate laundry which needs gentle treatment.



WOOL EXCELLENCE

For drying woolens labeled with the Woolmark TOTAL EASY CARE WOOL.



BIG ITEMS

For drying big laundry items, such as sleeping bags, blankets etc.



AIRING

For airing, refreshing and loosening up laundry without heating. Select the airing duration with option *Drying time*.



STEAM REFRESH

For refreshing laundry with steam. Specifically designed to refresh and remove odors from dry and clean casual garments like shirts, blouses, trousers made out of cotton, synthetics and their blends. Before loading the laundry into the drum, slightly humidify it by spraying it with water (maximum 200 ml; use a water spray bottle).

Dryness level *Cupboard dry* is preset and cannot be changed.

After programme end, unload the laundry immediately and put on clothes hangers to minimize creasing.



DRYING TIME

Time-restricted drying programme. Select programme duration with option *Drying time*.

For all fabrics appropriate for tumble drying. Suitable to add an additional short drying phase after programme end.

Refer to **OPTIONS, FUNCTIONS AND INDICATORS** / *option Drying time* for more information.

OPTIONS, FUNCTIONS AND INDICATORS

Refer to the programme chart to check which options are available for the selected programme.

OPTIONS WHICH ARE DIRECTLY SELECTABLE BY PRESSING THE RESPECTIVE BUTTON



Steam option

Minimizes creasing of garments made of cotton, synthetics and their blends by adding a humidifying phase at the end of the drying cycle.

Use the option with small loads only, unload the garments from the dryer immediately after programme end and put them on clothes hangers.

The humidity level automatically adjusts to *Cupboard dry* and cannot be changed with this option.

Not combinable with options *Fresh care*, *Rapid* and *Gentle*.



Drying time

To adjust the desired drying time, only if the *Drying time* or *Airing programme* has been selected.

Press the button; the drying time symbol on the display lights up. Turn the knob to select the desired drying time up to maximum 180 minutes, then press the knob to confirm it.

Not selectable for any other programme except the *Drying time* and *Airing programme*.



Dryness level

To select the desired dryness level for the laundry load. Press the button, then turn the knob to select the desired dryness level; chose between



Iron dry (suitable to be ironed after the drying cycle, therefore still slightly humid)



Cupboard dry (dry enough to be placed in a cupboard at the end of the drying cycle)



Extra dry (maximum dryness level)

and confirm by pressing the knob.

OPTIONS WHICH ARE SELECTABLE WITH THE OPTIONS BUTTON



Fresh Care

Helps to prevent creasing if you cannot unload the laundry soon after programme end.

The dryer starts to tumble the laundry periodically a few minutes after programme end. This tumbling will last up to approximately 12 hours after end of the programme. You can stop it at any time by switching off the dryer with the *On/Off button*.

Not combinable with *Steam option*.



Gentle

Enables a more gentle treatment of the laundry by reducing the drying temperature.

Not combinable with *Rapid* and *Steam option*.



Rapid

Enables quicker drying.

Not combinable with *Gentle* and *Steam option*.

FUNCTIONS



End of cycle signal

To switch on and off the signal tone at the end of the programme.



Key lock

To lock the keys and the knob of the control panel against unwanted operation.

To lock the keys:

- The dryer must be switched on.
- Press and hold the *Key lock button* « until the button lights up. Knob and keys are locked now.

Only the *On/Off button* works.

If you switch the dryer off and on again, the key lock will remain active until you unlock it.

To unlock the keys:

- Press and hold the *Key lock button* until the button light goes off.



Start delay

Moves the start of your programme to a later time. Choose a delay up to 23 hours.

- Select programme and options.
- Press the *Start delay button* « – the *Start delay symbol* on the display blinks.
- Turn the knob to select a delay up to 23 hours, which will be shown on the display. Press the knob to confirm.
- Press *Start / Pause* - the display shows the countdown of the delay until start of the programme. The *Start / Pause button* lights up. A sound by activation of the pump may occur.
- After the delay has expired, the dryer starts automatically. The display then indicates the remaining programme duration.

To cancel the *Start delay*

- Press *Start / Pause* to cancel the start delay (and press *Start / Pause* again to start the selected programme immediately).

INDICATORS



Water tank full

(=> empty water tank)



Bottom filter clogged

(=> clean bottom filter).



Door filter clogged

(=> clean door filter)

In case of any failures, refer to section **TROUBLESHOOTING** in the **USE AND CARE GUIDE**.

CARE AND MAINTENANCE

⚠ WARNING

Switch off and unplug the dryer before doing any cleaning and maintenance.

Caution, the water in the water tank can still be hot.

EMPTY WATER TANK AFTER EACH DRYING CYCLE

Hold the handle and carefully pull out the water tank. Hold the full water tank with both hands.

Empty the water and insert the container by pushing it back into place. Make sure that it is properly inserted.

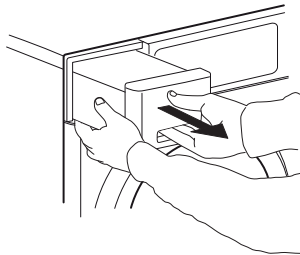

CLEAN DOOR FILTER AFTER EACH DRYING CYCLE

Open the door and remove the door filter by pulling it upwards.

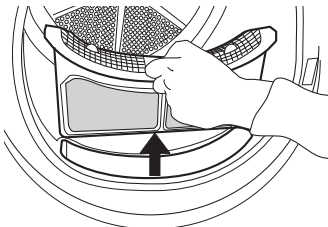

Press the button to open the door filter. Remove the lint inside. Close the filter and reinsert it in the right direction, so that it completely integrates in the filter chamber.

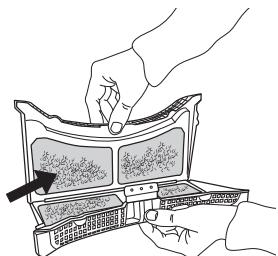

CLEAN THE BOTTOM FILTER AFTER ABOUT EVERY FIFTH DRYING CYCLE

Be Careful.

Some models are equipped with different filters, therefore some descriptions below may differ from the filter present in the dryer. All filters parts have to be cleaned

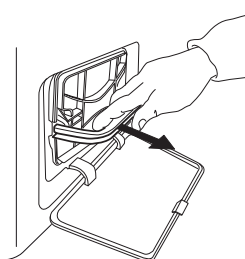

Open the bottom flap. Hold the handle and pull out the bottom filter.

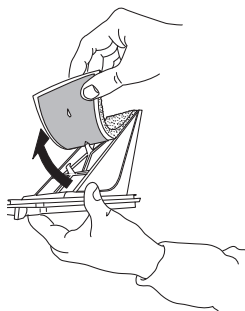

Remove the foam from the bottom filter, to clean it. Clean the filter foam and the filter by hand or under running water. Do not wash it in the washing machine. Wring out the filter foam. Do not insert it in the bottom filter dripping wet.

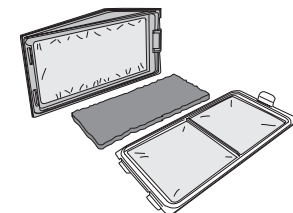

Fix the filter foam on the bottom filter. Clean the filter chamber of the dryer with a damp cloth or carefully with a vacuum cleaner. Insert the bottom filter again. Clap the filter handle down and close the bottom flap.

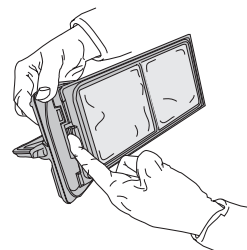

PRODUCT FICHE

📄 [www](http://www.docs.whirlpool.eu) The product fiche with energy data of this appliance can be downloaded from Whirlpool Website docs.whirlpool.eu

HOW TO OBTAIN THE USE AND CARE GUIDE

> 📄 [www](http://www.docs.whirlpool.eu) Download the Use and Care Guide from our website docs.whirlpool.eu (you can use this QR code), specifying the product's commercial code.

> Alternatively, contact our Client After-sales Service



CONTACTING OUR AFTER-SALES SERVICE

You can find our contact details in the warranty manual. When contacting our Client After-sales Service, please state the codes provided on your product's identification plate.

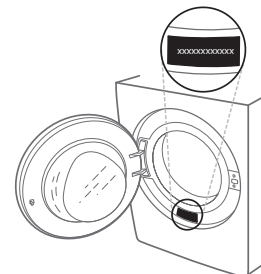

400011160413

Printed in Italy